

# SPECIFICATION

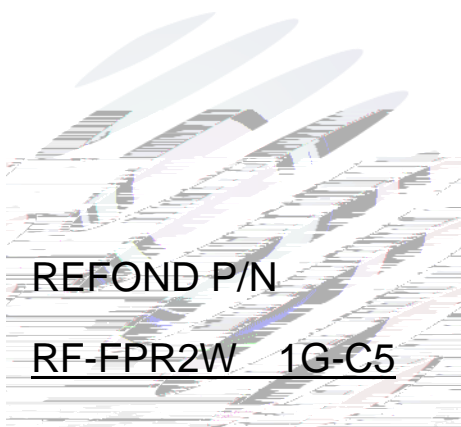

REFOND P/N

RF-FPR2W 1G-C5



Mass Product

## Contents

1.1 General Description	.....	3
1.2 Features	.....	3
1.3 Application	.....	3
1.4 Package Dimension	.....	4
1.5 Product Parameters	.....	5
1.6 Bin Range Of Luminous Flux and The Chromaticity Diagram (IF=20mA)	.....	BIN
(IF=20mA).....	.....	6
1.7 Typical optical characteristics curves	.....	8
2. Packaging	.....	11
2.1 Packaging Specification	.....	11
2.1.1 Suction box Dimension	.....	11
2.2 Moisture Resistant Packing	.....	12
2.3 Cardboard Box	.....	13
2.4 Reliability Test Items And Conditions	.....	13
2.5 Criteria For Judging Damage	.....	14
3. Handling Precautions	.....	15
3.1 Handling Precautions	.....	15

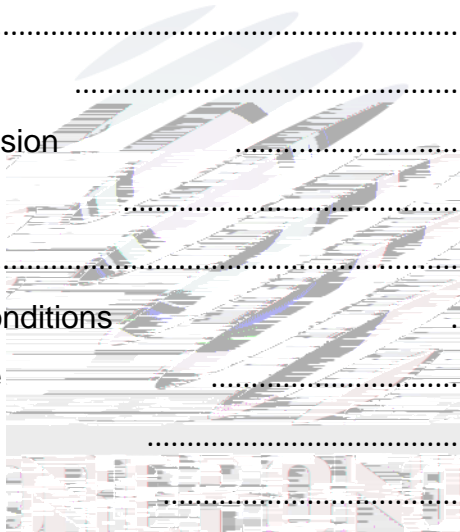

## 1. Description

### 1.1



The White LED which was fabricated using a blue chip and the phosphor LED

### 1.2 Features

Integrated Package.

360 ° Full Angle Luminescence. 360°

Suitable for spot welding process.

Moisture sensitivity level: Level 5. Level 5

RoHS compliant. RoHS

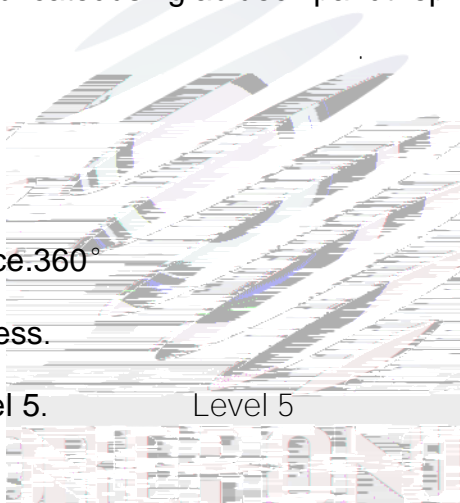

Product size: Length\* width\*thick 134mmX1.7mmX1.9mm

### 1.3 Application

Decorative applications.

Other indoor lighting.

## 1.4 Package Dimension

Fig.1-1 Top view

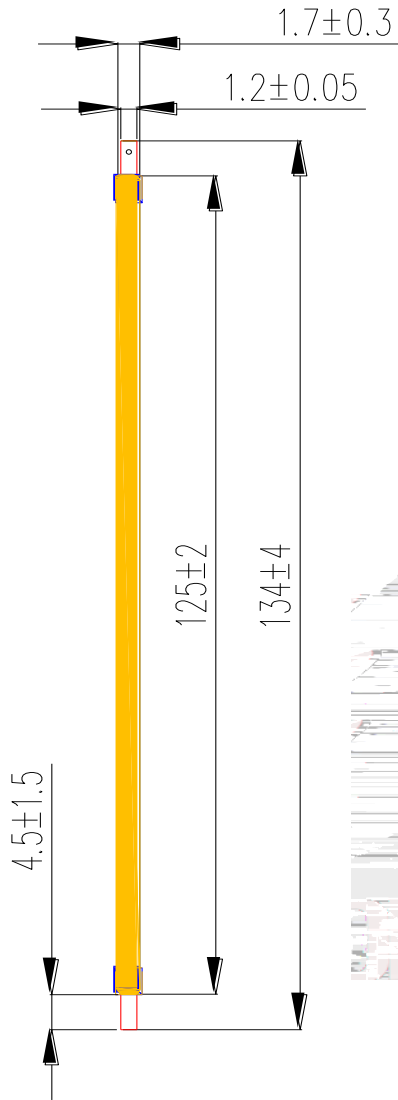
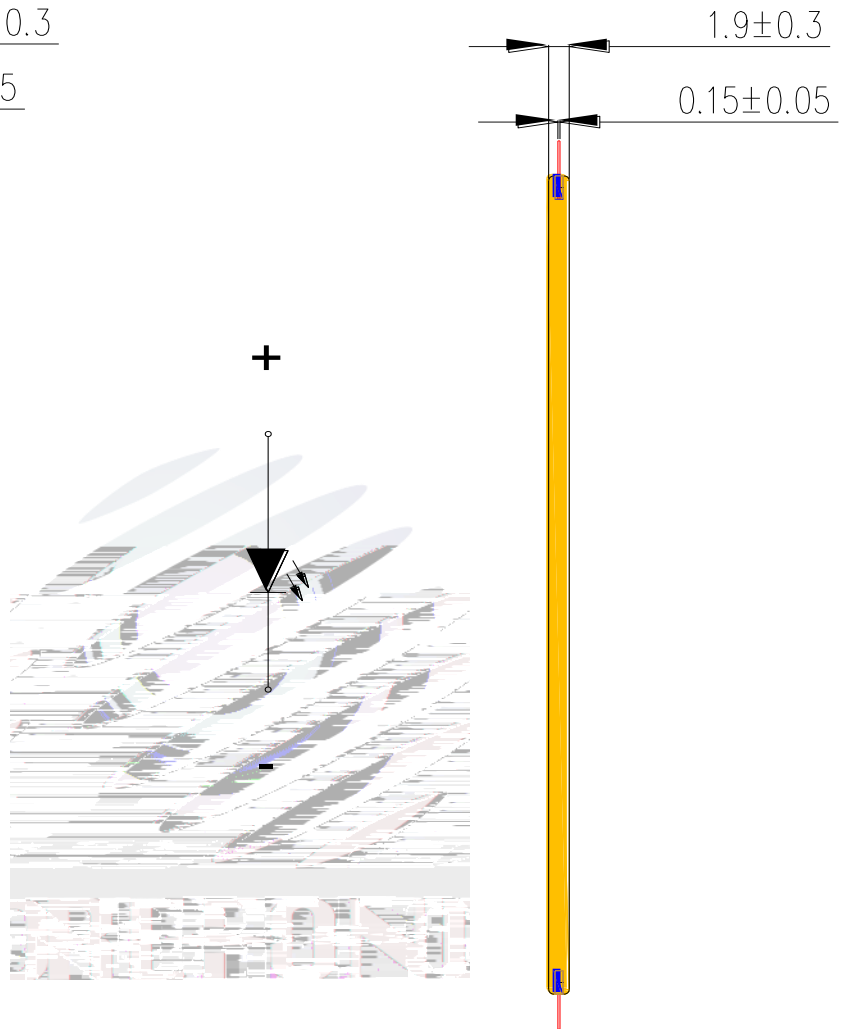

Fig.1-2 Bottom view



### Notes

1. All dimensions units are millimeters.
2. All dimensions tolerances are  $\pm 0.5\text{mm}$  unless otherwise noted.

0.5

## 1.5 Product Parameters

Table 1-1 Electrical / Optical Characteristics at Ts=25°C

Item	Symbol	Test Condition	Value			Unit
			Min.	Typ	Max.	
Forward Voltage	$V_F$	$I_F=20\text{mA}$	132	---	138	V
Leakage current	$V_f$	$I_f=10\mu\text{A}$	100	---	---	$\mu\text{A}$
Luminous Flux		$I_F=20\text{mA}$	220	---	310	lm
Viewing Angle		$I_F=20\text{mA}$	---	---	360	deg
Color Rendering Index	$R_a$	$I_F=20\text{mA}$	93	---	---	/
Color Rendering Index	$R_9$	$I_F=20\text{mA}$	45	---	---	/
Thermal Resistance.	$R_{THJ-S}$	$I_F=20\text{mA}$	---	---	70	$^{\circ}\text{C/W}$

Table 1-2 Absolute Maximum Ratings at Ts=25°C

Parameter	Symbol	Rating	Units
Power Dissipation	$P_D$	2760	mW
Forward Current	$I_F$	20	mA
Peak Forward Current	$I_{FP}$	23	mA
Electrostatic Discharge (HBM)	$E_{SD}$	2000	V
Operating Temperature	$T_{OPR}$	-40 ~ +85	$^{\circ}\text{C}$
Storage Temperature	$T_{OPR}$	-40 ~ +85	$^{\circ}\text{C}$
Junction Temperature	$T_J$	110	$^{\circ}\text{C}$

### Notes

1. 1/10 Duty cycle, 0.1ms pulse width.      0.1ms,      1/10.

- 2. The above forward voltage measurement allowance tolerance is  $\pm 1V$ .
- 3. The above color coordinates measurement allowance tolerance is  $\pm 0.005$ .  $\pm 0.005$ .
- 4. The above luminous intensity measurement allowance tolerance  $\pm 10\%$ .  $\pm 10\%$ .
- 5. Care is to be taken that power dissipation does not exceed the absolute maximum rating of the product.
- 6. All measurements were made under the standardized environment of Refond.
- 7. When the LEDs are in operation the maximum current should be decided after measuring the package temperature junction temperature should not exceed the maximum rate. LED

- 8. ESD yield is over 90% at 2000V ESD (HBM). ESD protection during products handing is needed. 90% LED  
ESD2000V
- 9. The filament is a non-spectroscopic product, and the commitment batch meets the optical/electrical parameter range of more than 90%. 90%

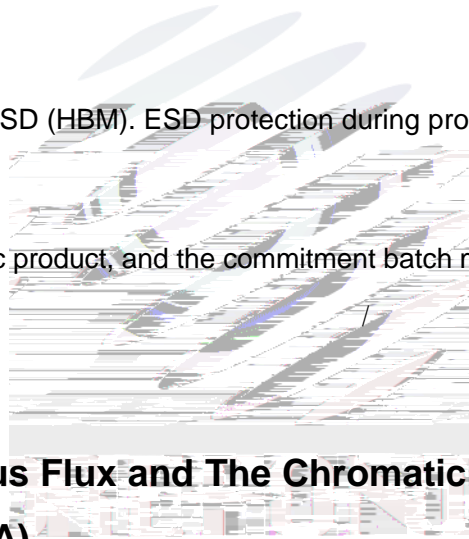

### 1.6 Bin Range Of Luminous Flux and The Chromaticity Diagram (IF=20mA)

**BIN (IF=20mA)**

Table 1-3

RF-FPR2W2C1G-C5 2200K	Rank250	
	220	280
RF-FPR2W2E1G-C5 2700K	Rank280	
	250	310

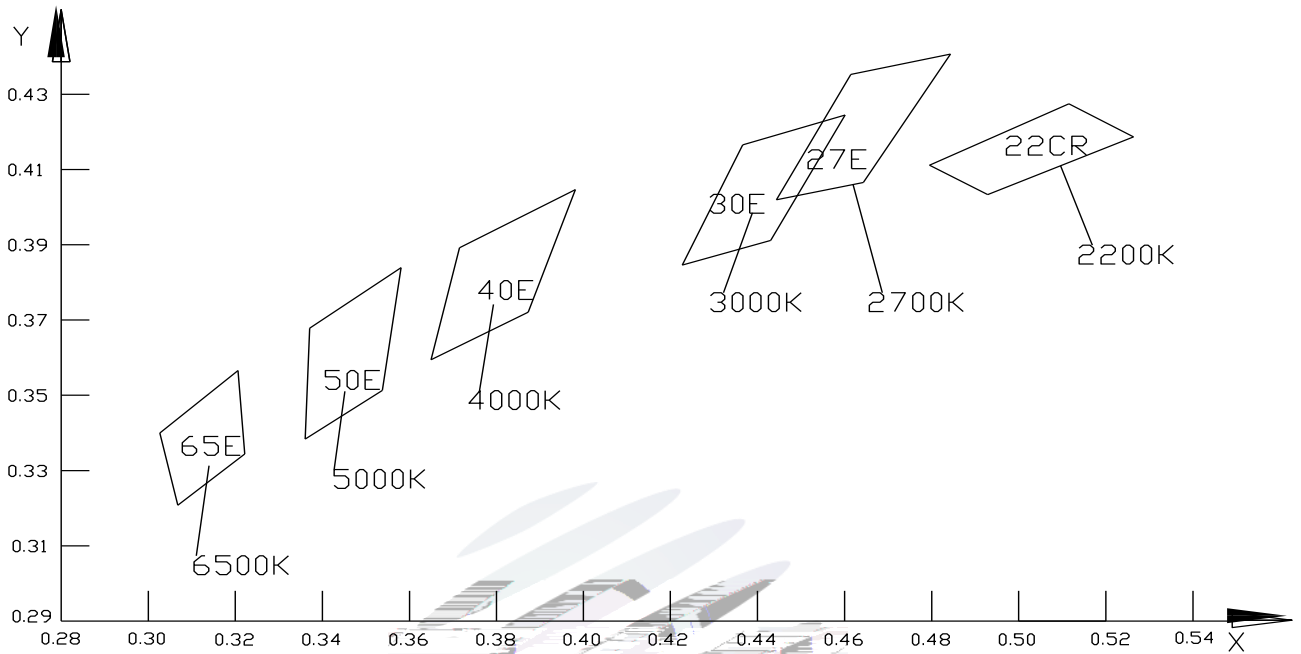

Fig 1-3 The C.I.E Chromaticity Diagram CIE

Table 1-4

BIN CODE	CIE-X1	CIE-Y1	CIE-X2	CIE-Y2	CIE-X3	CIE-Y3	CIE-X4	CIE-Y4
22CR	0.4795	0.4111	0.5116	0.4274	0.5264	0.4187	0.4929	0.4033
27E	0.4443	0.4019	0.4615	0.4353	0.4843	0.4407	0.4643	0.4065

### 1.7 Typical optical characteristics curves

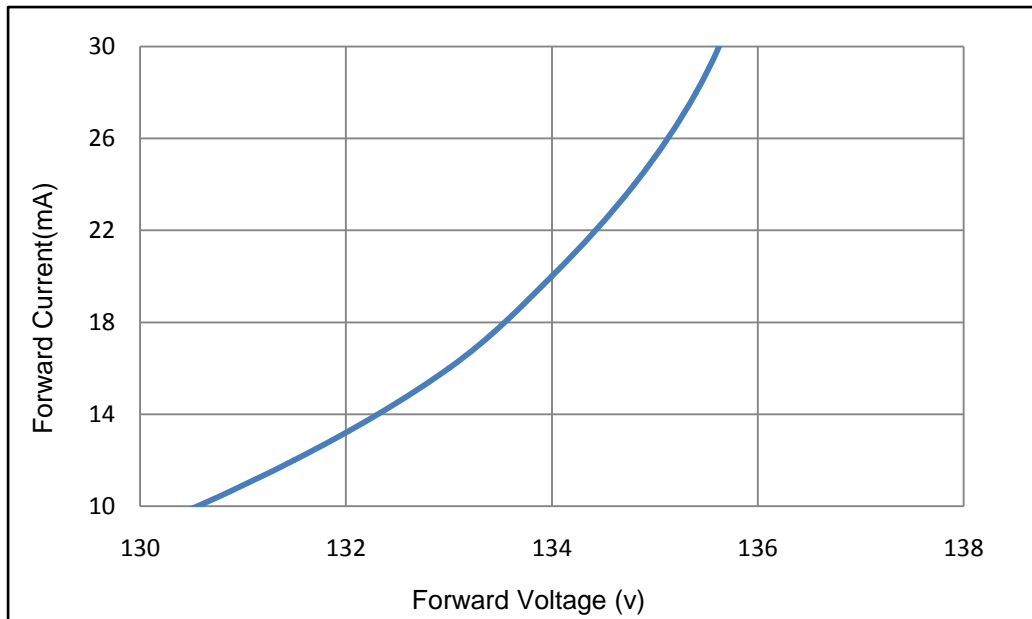

Fig 1-1 Forward Voltage Vs. Forward Current

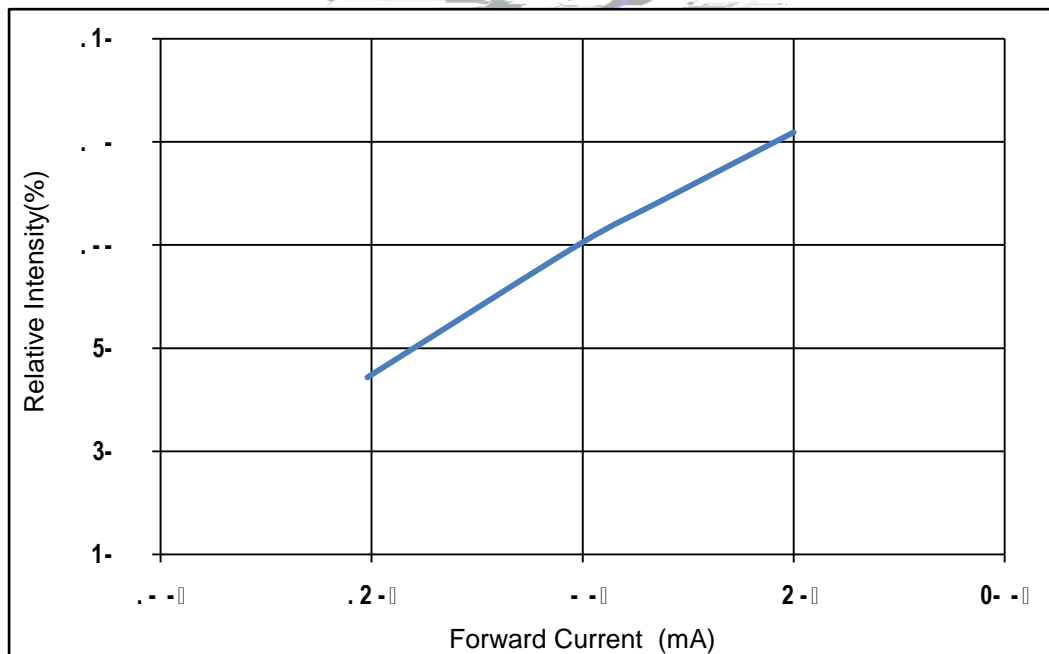

Fig 1-2 Forward Current Vs. Relative Intensity



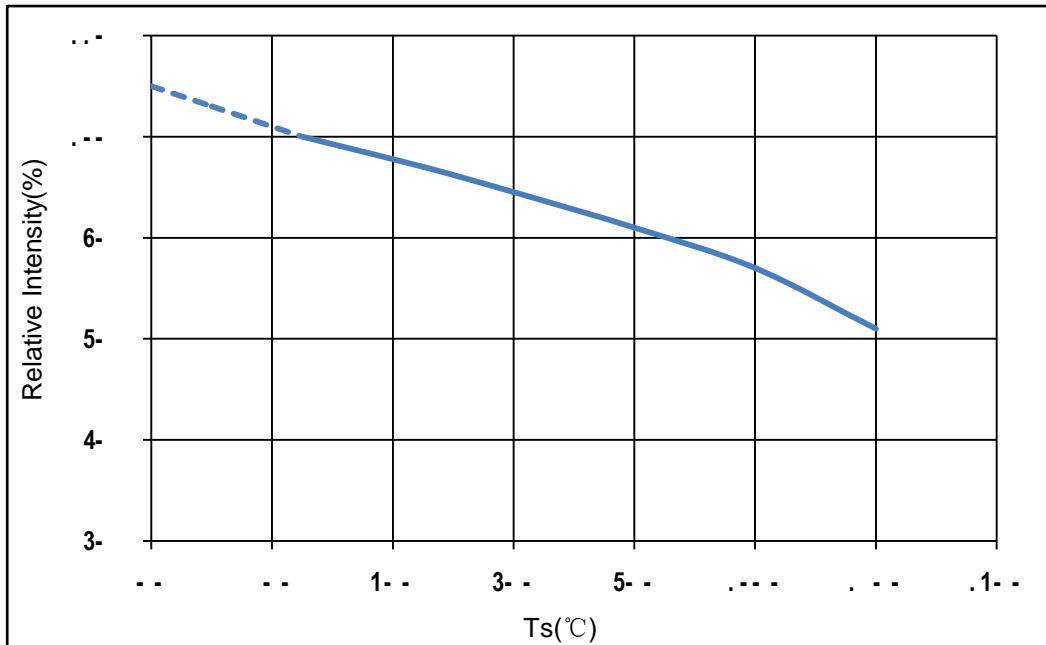

Fig 1-3 Central surface temperature Vs Relative Intensity

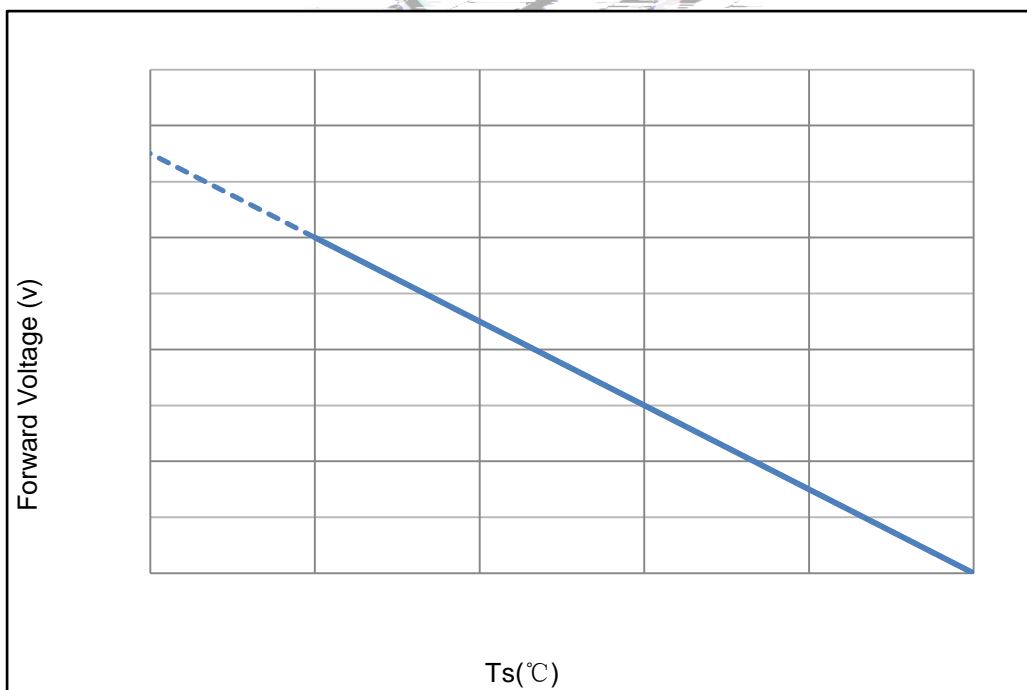

Fig 1-4 Forward Voltage Vs Central surface temperature

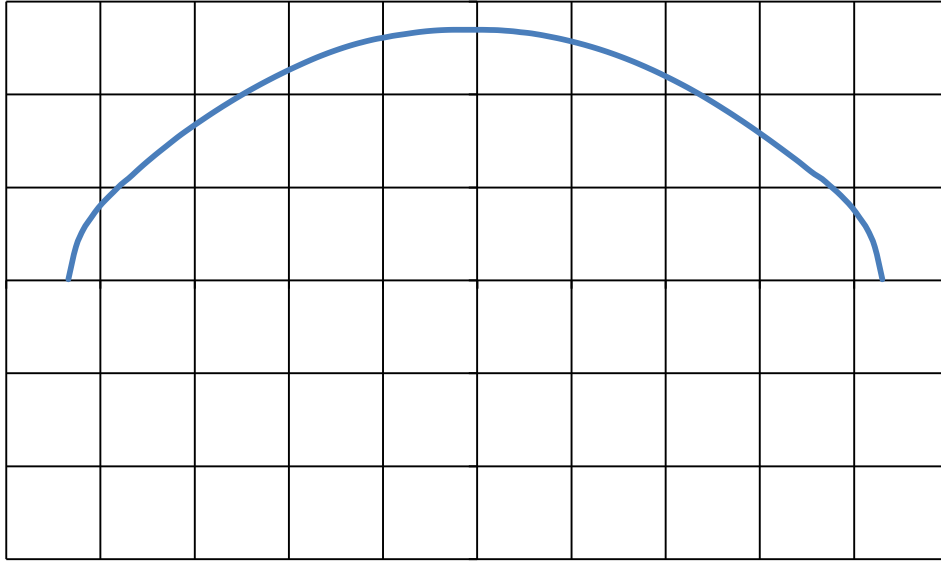

Fig 1-5 Radiation diagram

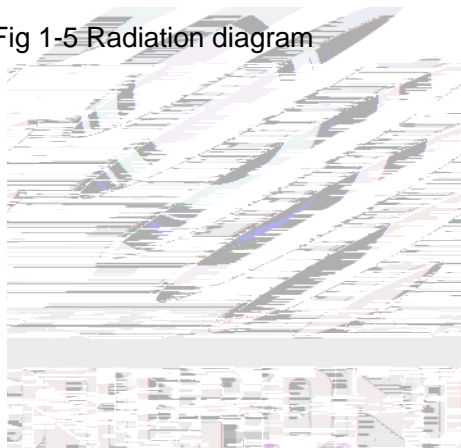



Fig 1-6 Spectrum Distribution



### 2.1.2 Label Form Specification

Table 2-2 Title

P/N		
Bom	S/N:	
L/N:		
Bin Code:	X/Y	
Φ:	Ra:	
Vf	QTY:	
	DATE:	
Web:www.refond.com		

P/ N	Part Number
S/N	Spec Number
L/N	Lot Number
Bin Code	Bin Code
	Luminous flux
X/Y	Chromaticity Bin
V <sub>F</sub>	Forward Voltage
Ra	Color Rendering Index
QTY	Packing Quantity
DATE	Made Date

Fig 2-3 Title

### 2.2 Moisture Resistant Packing

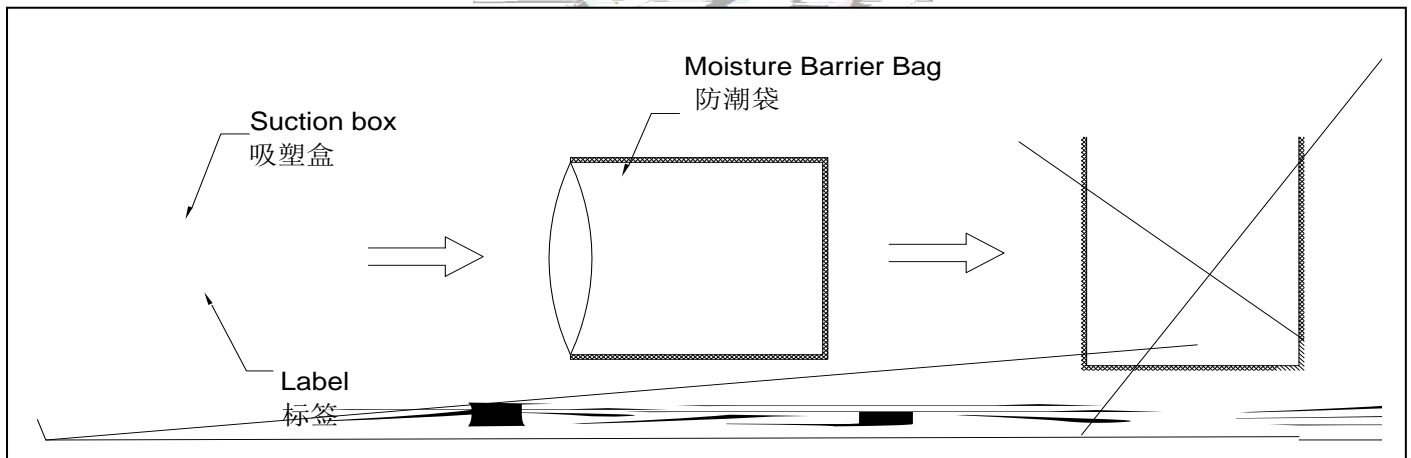

Fig.2-3Moisture Resistant Packing

## 2.3 Cardboard Box

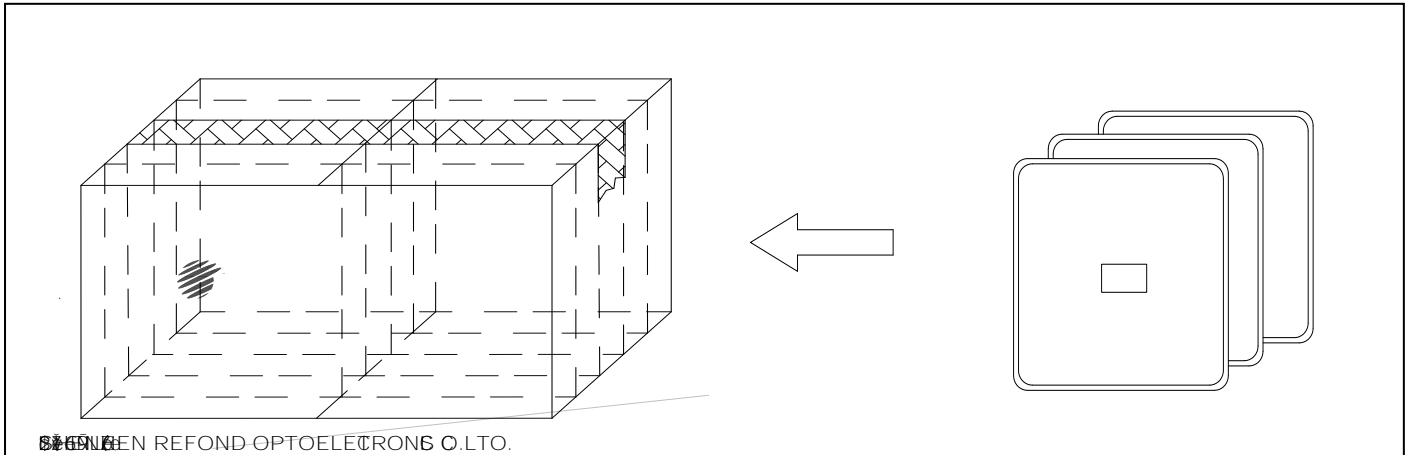

Fig.2-4 Cardboard Box

## 2.4 Reliability Test Items And Conditions

Table 2-3 Reliability Test Items And Conditions

Test Items	Ref. Standard	Test Condition	Time	Quantity	Ac/Re
Thermal Shock	JEITAED-4701 300307	-40 15min 10s 100 15min	100 cycle	20pcs	0/1
Switching Test	/	25°C, On 2.5min Off 2.5min	2500cycle	20pcs	0/1
Life Test	JESD22-A108	Ta=25 If=20mA	1000hrs	10pcs	0/1
High Temperature High Humidity Life Test	JESD22-A101	60 / 90%RH If=20mA	500hrs	10pcs	0/1

## 2.5 Criteria For Judging Damage

Table 2-4 Criteria For Judging Damage

Test Items	Symbol	Test Condition	Criteria For Judgement	
			Min.	Max.
Forward Voltage	$V_F$	$I_F=20mA$	L.S.L*)x0.90	U.S.L*)x1.1
Luminous Flux		$I_F=20mA$	No open circuit, shortcircuit or flicke	

### Notes

- 1.U.S.L: Upper standard level      L.S.L: Lower standard level
2. The above reliability tests is based on the verification of a single/strip LED of Refond's existing experimental platform, the reliability experiment was taken under good heat dissipation conditions. when customers applies the LED to the series and parallel circuit, should take consideration of all the factors such as the current, voltage distribution, heat dissipation and others. / LED
- 3.The technical information shown in the data sheets are limited to the typical characteristics and circuit examples of the referenced products. It does not constitute the warranting of industrial property nor the granting of any license.

### 3. Handling Precautions

#### 3.1 Handling Precautions

(1) LED operating environment and sulfur element composition cannot be over 100PPM in the LED mating usage material. This is provided for informational purposes only and is not a warranty or endorsement. LED LED 100PPM.

(2) In order to prevent external material from getting into the inside of LED, which may cause the malfunction of LED, the single content of Bromine element is required to be less than 900PPM, the single content of Chlorine element is required to be less than 900PPM, the total content of Bromine element and Chlorine element in the external materials of the application products is required to be less than 1500PPM. This is provided for informational purposes only and is not a warranty or endorsement.



(3) VOCs (Volatile organic compounds) emitted from materials used in the construction of fixtures can penetrate silicone encapsulants of LEDs and discolor when exposed to heat and photonic energy. The result can be a significant loss of light output from the fixture. Knowledge of the properties of the materials selected to be used in the construction of fixtures can help prevent these issues. Refond advises against the use of any chemicals or materials that have been found or are suspected to have an adverse effect on device performance or reliability. To verify compatibility, Refond recommends that all chemicals and materials be tested in the specific application and environment for which they are intended to be used. Attaching LEDs, do not use adhesives that outgas organic vapor. LED

LED

LED

LED

(4) Handle the component along the side surface by using forceps or appropriate tools; do not directly touch or Handle the silicone lens surface, it may damage the internal circuitry.

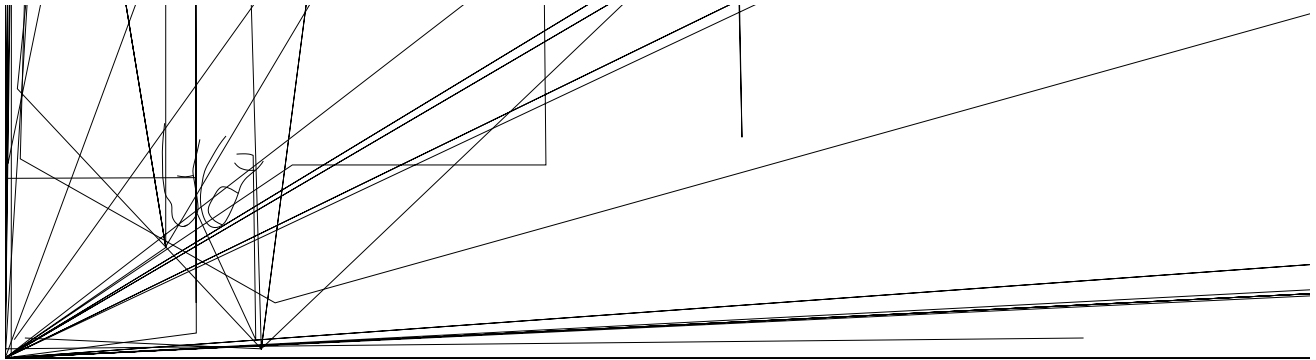
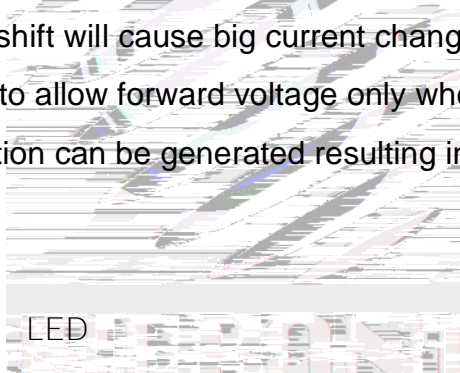

Fig 4-1 Clip filament specification

(5) In designing a circuit, the current through each LED must be exceed the absolute maximum rating specified for each LED. In the meanwhile, resistors for protection should be applied, otherwise slight voltage shift will cause big current change, burn out may happen. The driving circuit must be designed to allow forward voltage only when it is ON or OFF. If the reverse voltage is applied to LED, migration can be generated resulting in LED damage.

LED



LED

(6) Thermal Design is paramount importance because heat generation may result in the Characteristics decline, such as brightness decreased, Color change and so on. Please consider the heat generation of the LEDs when making the system design. LED

LED

(7) Compared to standard encapsulants, silicone is generally softer, and the surface is more likely to attract dust requiring special care during processing. In cases where a minimal level of dirt and dust particles cannot be guaranteed, a suitable cleaning solution must be applied to the surface after the soldering of components. Refond suggests using isopropyl alcohol for cleaning. In case other solvents are used, it must be assured that these solvents do not dissolve the package or resin. Ultrasonic cleaning is not recommended. Ultrasonic cleaning may cause









Declare

This specification is written both in English and in Chinese and the latter is formal.