

# SPECIFICATION

REFOND P/N

RF-\*\*QI32DS-DF-N

D<sup>~</sup> 6

Mass Product

---

## Contents

1. Description	3
1.1 General Description	3
1.2 Features	3
1.3 Application	3
1.4 Package Dimension	4
1.5 Product Parameters	5
1.6 Bin Range Of Forward Voltage and Luminous Flux	<b>BIN</b> 7
1.7 Typical optical characteristics curves	8
2. Packaging	12
2.1 Packaging Specification	12
2.1.1 Carrier Tape Dimension	12
2.1.2 Reel Dimension	12
2.1.3 Label Form Specification	13
2.2 Moisture Resistant Packing	13
2.3 Cardboard Box	13
2.4 Reliability Test Items And Conditions	14
2.5 Criteria For Judging Damage	15
3. SMT Reflow Soldering Instructions SMT	16
3.1 SMT Reflow Soldering Instructions SMT	16
4. Handling Precautions	18
4.1 Handling Precautions	18

## 1. Desc

### 1.1 General Description

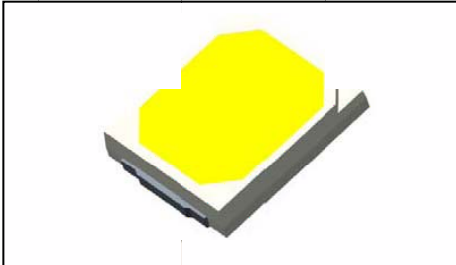

The White LED which was fabricated using  
Product Package:  $5.0 \times 5.0 \times 0.8$  mm  
>76

### 1.2 Features

- y PLCC-2 Package.
- y Extremely wide viewing angle.
- y Suitable for all SMT assembly and solder
- y Available on tape and reel.
- y Moisture sensitivity level: Level 3.
- y RoHS compliant. DoHE

### 1.3 Application

- y Indoor lighting.
- y Bulb lighting.
- y General indoor applications.

### 1.4 Package Dimension

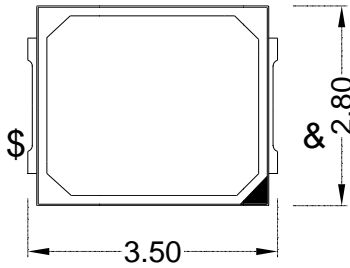

Fig.1-1 Top view

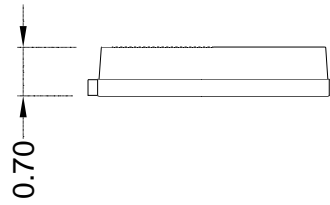

Fig.1-2 Side view

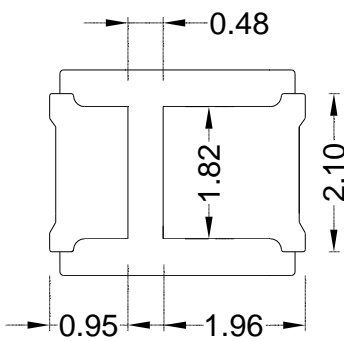

Fig.1-3 Bottom view

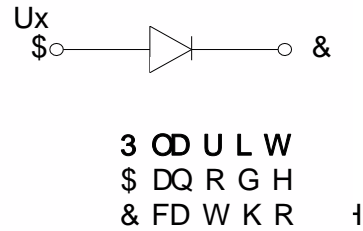

Fig.1-4 Polarity

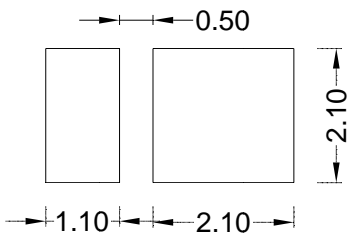

Fig.1-5 Soldering patterns

Notes

#ž All dimensions units are millimeters.

Šž All dimensions tolerances are ±0.05mm unless otherwise noted.

f "ž"

## 1.5 Product Parameters

Table 1-1 Ele

r

Item
Forward Voltage
Reverse Current
RF-27QI32DS-DF-N 2580-2880K
RF-W57QI32DS-DF-N 5270-6090K
Viewing Angle
Color Rendering Index
Thermal Resistance.
Electrostatic Discharge(HBM)

T:

Parameter
Power Dissipation
Forward Current
Peak Forward Current
Reverse Voltage
Operating Temperature
Storage Temperature
Junction Temperature

Notes

1. 1/10 Duty cycle, 10ms pulse width.  $P_{\pm} \pm 10\text{ms}, \# J$ ; | 1/10.
2. The above forward voltage measurement allowance tolerance is  $\pm 0.1\text{V}$ .  $f \# \checkmark$
3. The above color coordinates measurement allowance tolerance is  $\pm 0.003$ .  $\pm 0.003$ .
4. The above luminous intensity measurement allowance tolerance  $\pm 10\%$ .  
 $f \# \checkmark$
5. Care is to be taken that power dissipation does not exceed the absolute maximum rating of the product.
6. All measurements were made under the standardized environment of Refond.
7. When the LEDs are in operation the maximum current should be decided after measuring the package temperature. junction temperature should not exceed the maximum rate  $\checkmark > 76$

## 1.6 Bin Range Of Forward Voltage and Luminous Flux

BIN

Table 1-3

VF(V)	G1	G2	H1
	2.8-2.9	2.9-3.0	3.0-3.1
- (LM)	PED	QED	QGD
	18-20	20-22	22-24

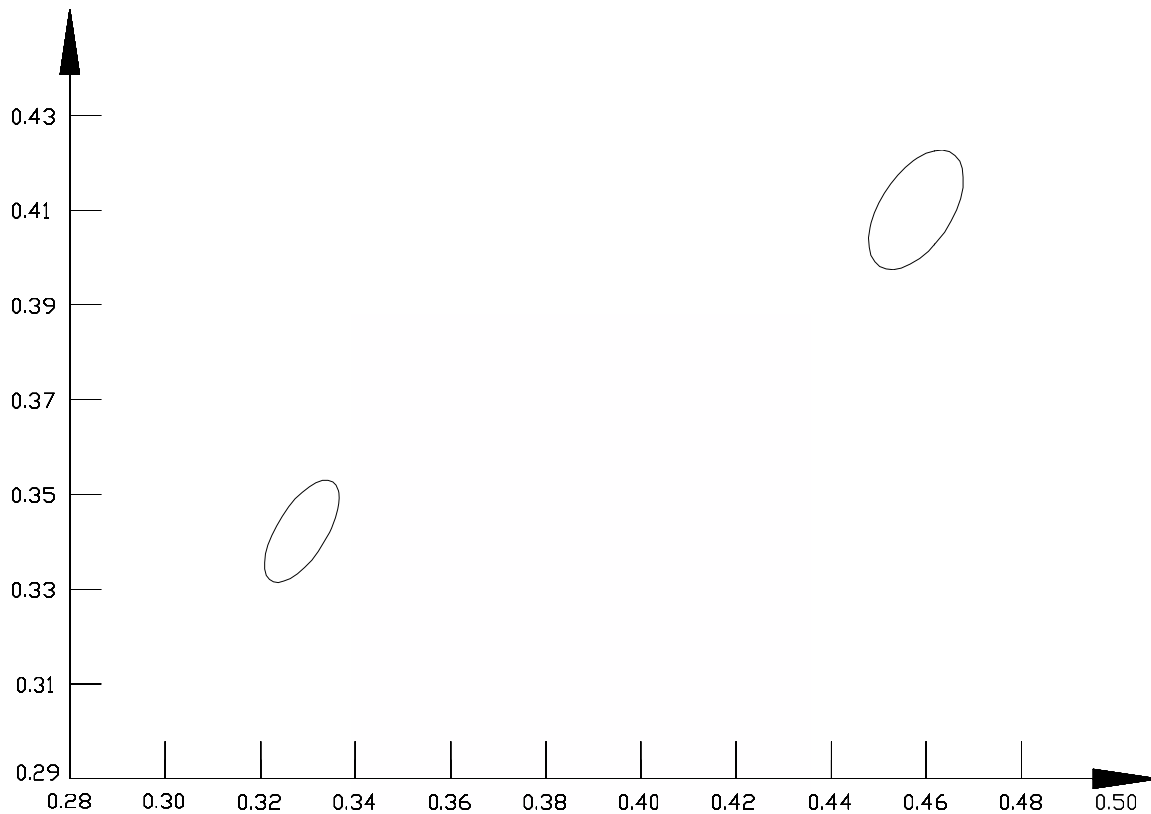

Fig 1-6 The C.I.E Chromaticity Diagram CIE

Table 1-4

BINCODE	Center (x,y)		a	b	
	X	Y			
A27	0.4578	0.4101	0.0129	0.0069	57.17
A57	0.3287	0.3422	0.0112	0.0048	58.14

### 1.7 Typical optical characte



Fig 1-7Fon

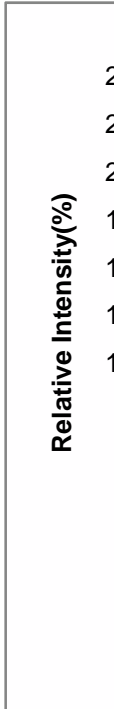

Fig 1-8 Forward Cu



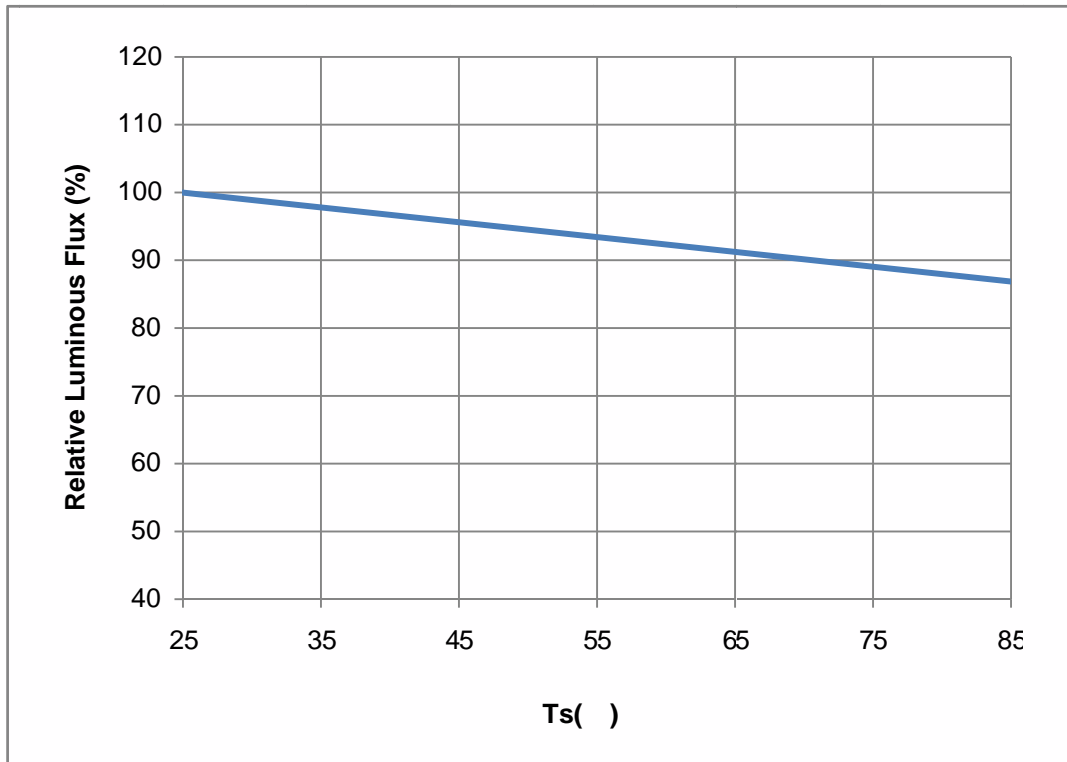

Fig 1-9 Solder Temperature Vs Relative Intensity

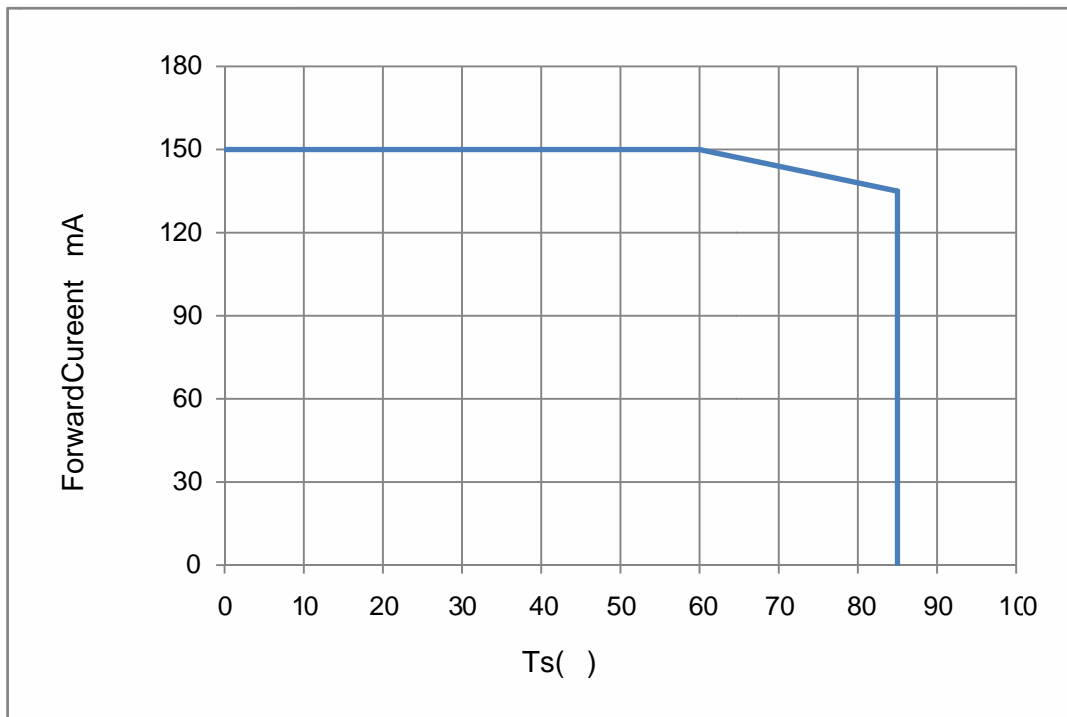

Fig 1-10 Solder Temperature Vs. Forward Current

Tj 115

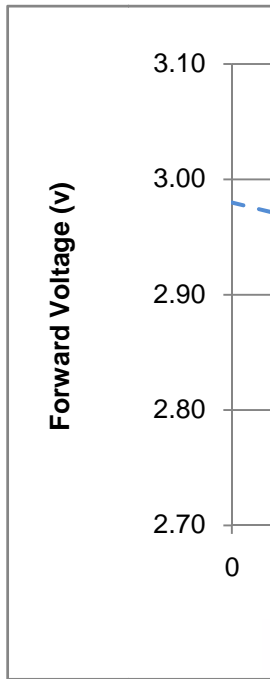

Fig 1-11 Forward Voltage Vs S

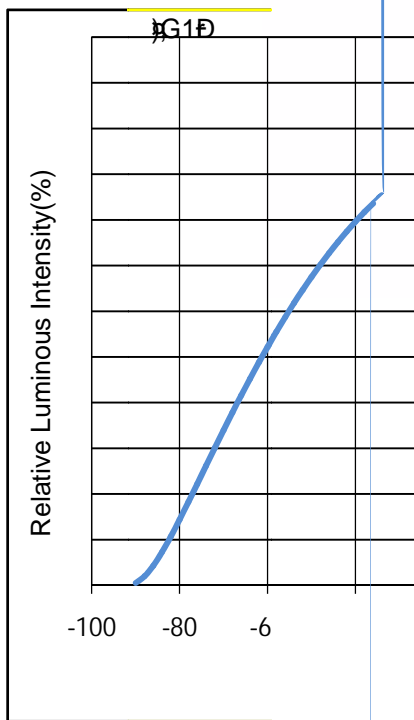

Fig 1-12 Radia



## 2. Pack

### 2.1 Packaging Specification

Package:12000/4000pcs/reel.

#### 2.1.1 Carrier Tape Dimension

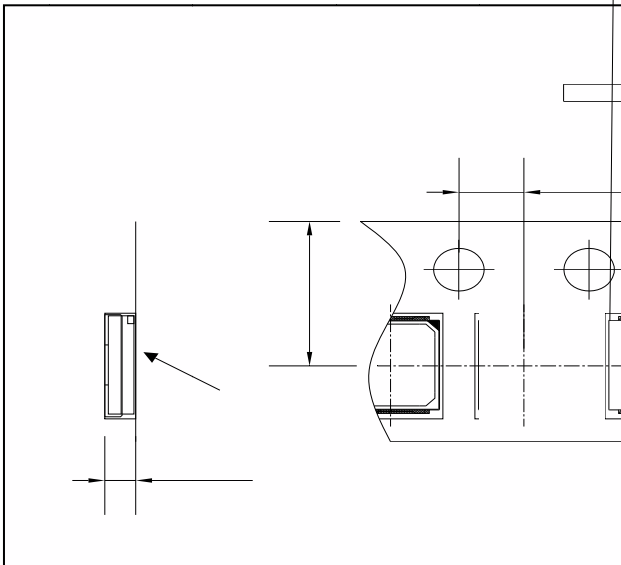
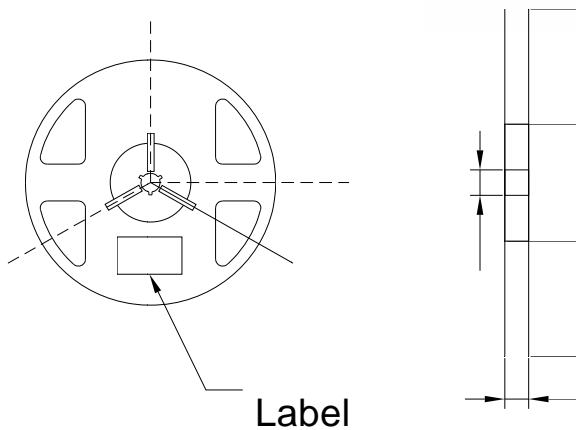

Fig.2-1 Carrier

#### 2.1.2 Reel Dimension



Label

Fig.2-2Title

#### Notes

The tolerances unless mentioned  $\pm 0.1\text{mm}$ . Unit : r

### 2.1.3 Label Fc

PART N°
SPEC N°
LOT N°
BIN COE
Φ :
VF :

### 2.2 Moisture

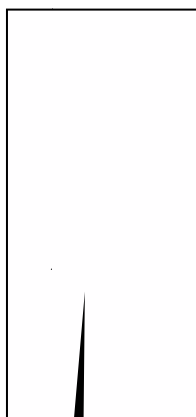

### 2.3 Cardboard

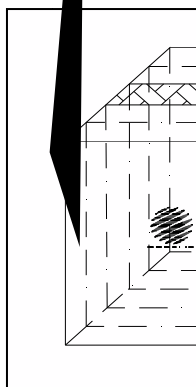

## 2.4 Reliability Test Items And Cond

T

TestItems	Ref.Standard
Reflow	JESD22-B106
Thermal Shock	JEITAED-4701 300307
High Temperature Storage	JEITAED-4701 200201
Low Temperature Storage	JEI
Life Test	JEI
High Temperature High Humidity Life Test	JEI
Temperature Humidity Storage	JEI

## 2.5 Criteria For Judging Damage

Table 2-4 Title

Test Items	Symbol	Test Condition	Criteria For Judgement	
			Min.	Max.
Forward Voltage	$V_F$	$I_F=60mA$	-	$(U.S.L^*) \times 1.1$
Reverse Current	$I_R$	$V_R = 5V$	-	$(U.S.L^*) \times 2.0$
Luminous Flux	N	$I_F=60mA$	$(L.S.L^*) \times 0.7$	-

### Notes

1.U.S.L: Upper standard level

L.S.L: Lower standard level

2. The above reliability tests is based on the verification of a single/strip LED of Refond's existing experimental platform, the reliability experiment was taken under good heat dissipation conditions. when customers applies the LED to the series and parallel circuit, should take consideration of all the factors such as the current, voltage distribution, heat dissipation and others. / LED

LED

3.The technical information shown in the data sheets are limited to the typical characteristics and circuit examples of the referenced products. It does not constitute the warranting of industrial property nor the granting of any license.

### 3.1 SMT Re

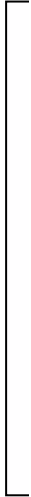

Average
Preheati
Preheati
Preheati
Time lim
Time lim
Peak /Cl
Time lim t <sub>p</sub>
Hold tim
Cooling
Needed



## Notes

(1) Reflow soldering should be done after first, LEDs v  
>76

(2) When soldering, do not

### 3.1.1 Soldering Iron

(1) When hand soldering

(2) The hand solder should

### 3.1.2 Repair

Repair should be done as  
unavoidable, and  
confirmed in :

LED

>76

### 3.1.3 Caution

The enclosure should be opened from  
the top of package

Precautions :

Use the pickin

(2) Components

do not warp

(3) Do not apply mechanical force or excess vibration during the cooling process to normal temperature after soldering. Do not rapidly cool device after soldering.

## 4. Handling Precautions

### 4.1 Handling Precautions

(1) LED operating environment and sulfur element composition cannot be over 100PPM in the LED mating usage material. This is provided for informational purposes only and is not a warranty or endorsement. LED >76 # " PP? ž

(2) In order to prevent external material from getting into the inside of LED, which may cause the malfunction of LED, the single content of Bromine element is required to be less than 900PPM, the single content of Chlorine element is required to be less than 900PPM, the total content of Bromine element and Chlorine element in the external materials of the application products is required to be less than 1500PPM. This is provided for informational purposes only and is not a warranty or endorsement. >76 >76 + " PP? + " PP? # " PP? ž

(3) VOCs (Volatile organic compounds) emitted from materials used in the construction of fixtures can penetrate silicone encapsulants of LEDs and discolor when exposed to heat and photonic energy. The result can be a significant loss of light output from the fixture. Knowledge of the properties of the materials selected to be used in the construction of fixtures can help prevent these issues. Refond advises against the use of any chemicals or materials that have been found or are suspected to have an adverse affect on device performance or reliability. To verify compatibility, Refond recommends that all chemicals and materials be tested in the specific application and environment for which they are intended to be used. Attaching LEDs, do not use adhesives that outgas organic vapor. >76

>76

>76

>76

(4) Handle the component along the edges. Do not directly touch or Handle the silicon

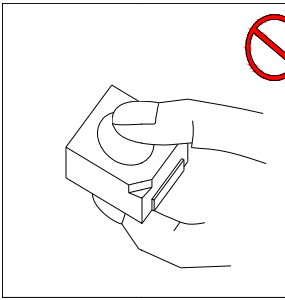

(5) In designing a circuit, the current rating specified for each LED. In the applied, otherwise slight voltage slight driving circuit must be designed to voltage is applied to LED, migration

>76

(6) Thermal Design is paramount Characteristics decline, such as brightness the heat generation of the LEDs v

#

(7) Compared to standard to attract dust, requiring dust particles cannot be after the soldering of components

other solvents are used, it must be assured that these solvents do not dissolve the package or resin. Ultrasonic cleaning is not recommended. Ultrasonic cleaning may cause damage to the LED.

>76

Table 4-1 Storage

Conditions		Temperature	Humidity	Time
Storage	Before Opening Aluminum Bag	30	75%	Within 1 Year From Date
	After Opening Aluminum Bag	30	60%	24hours 24
Baking		60 ± 5	-	24hours 24

(8) If the moisture absorbent material (silica gel) has faded away or the LEDs have exceeded the storage time, baking treatment should be performed after unpacking and based on the following condition: 60 ± 5 °C for above 24 hours.

( " f '                      \$&

If the package is flatulence or damaged, please notify the sales staff to assist.

(9) Similar to most Solid state devices; LEDs are sensitive to Electro-Static Discharge (ESD) and Electrical Over Stress (EOS).

>76

(10) Other points for attention, please refer to our relevant information.

Ve





[www.refond.com](http://www.refond.com)

Declare

This specification is written both in English and in Chinese and the latter