

SPECIFICATION

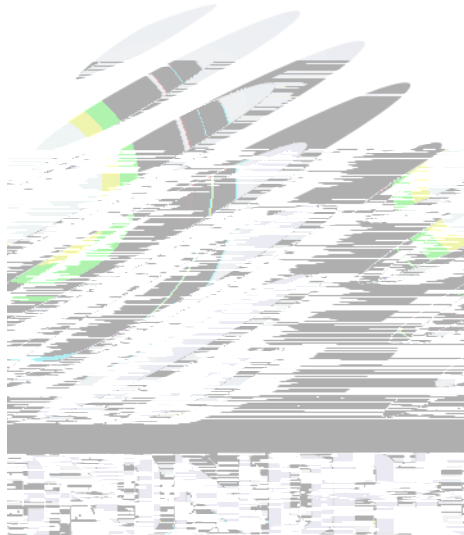

R & D

Mass Product

Contents

1. Product Description/	
2.Product Specification /	
2.1 Optical-electrical Characteristics(Absolute Maximum Ratings At Ts=25)/	.4
2.2 Product Schematic And Interface Definition/5
2.3 Product Module rule of naming	:5
3. Product Specification /	
3.1 Outline Dimension /6
4. Product Reliability Test/	
5. Product Materials Performance Test And Method At Ta=25 /	
6.Packing Criterion/	
6.1 Package Diagram /9
6.2 Carton silk printing/9
6.3Label Form Specification/9
7. Handling Precautions	

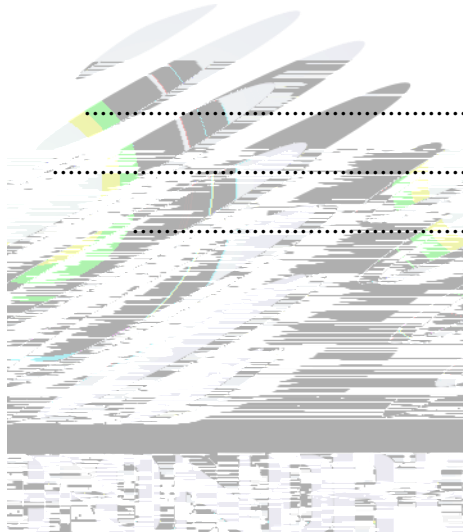

1. Product Description/

high reliability and high safety;

2835 LED Package, high lighting efficiency, low heat, without Mercury, belong to the environmental protection cold light source;

2835LED

The protection of the lamp is up to IP67, with beautiful appearance, no fouling situation.

IP67



2.Product Specification /

2.1 Optical-electrical Characteristics(Absolute Maximum Ratings At Ts=25)/

Tab.2-1Optical-electrical Characteristics

Refond PN	Customer PN	Module Characteristics				
		Current mA	Voltage(V)	Power(W)	Module LM	
		Typ	Typ	Typ	Min	Max
RF-MTB652T06-A1 6000-6500K	-	250	24			

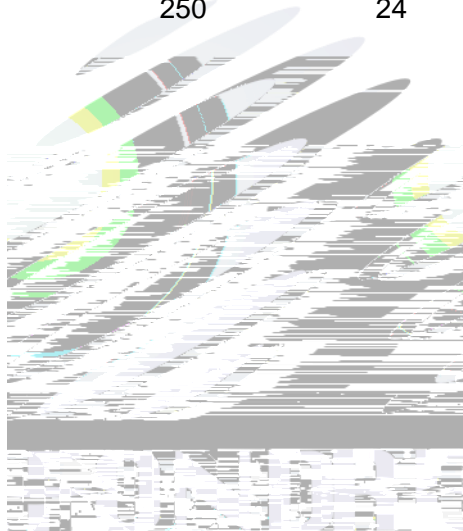

2.2 Product Schematic And Interface Definition/

Fig.2-2 Product connection

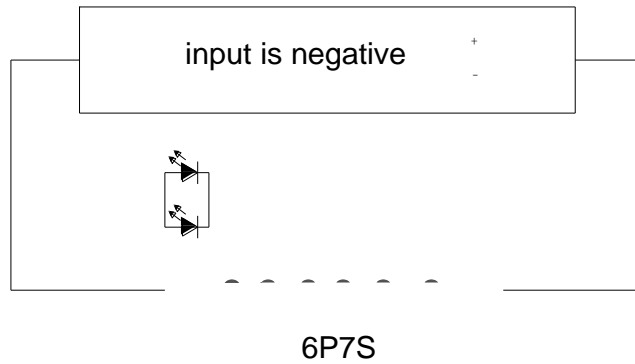

2.3 Product Module rule of naming :

RF MT B 65 2 T 06 B 1

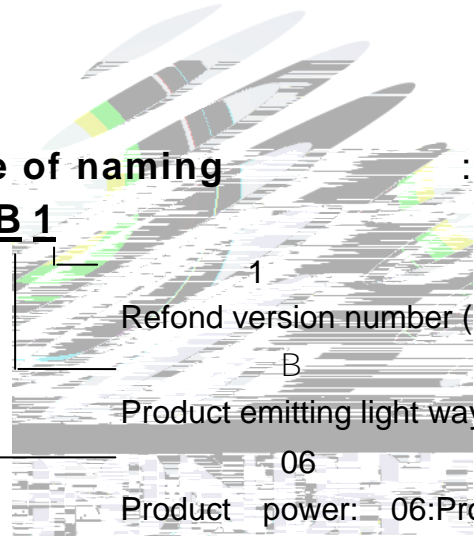

1
Refond version number (1: the first version)

B
Product emitting light way B Top view

06 6W
Product power: 06:Product is 6W

H: 85≥T 80
Product CRI H: 85≥T 80

LED 2 2835
LED Package type 2 2835

65:6000-6500K
Product CCT 65:6000-6500K

B:
Product type (B: Freezer lights)

Module department code
RF:
Refond company abbreviation(RF: Refond)

3. Product Specification /

3.1 Outline Dimension /

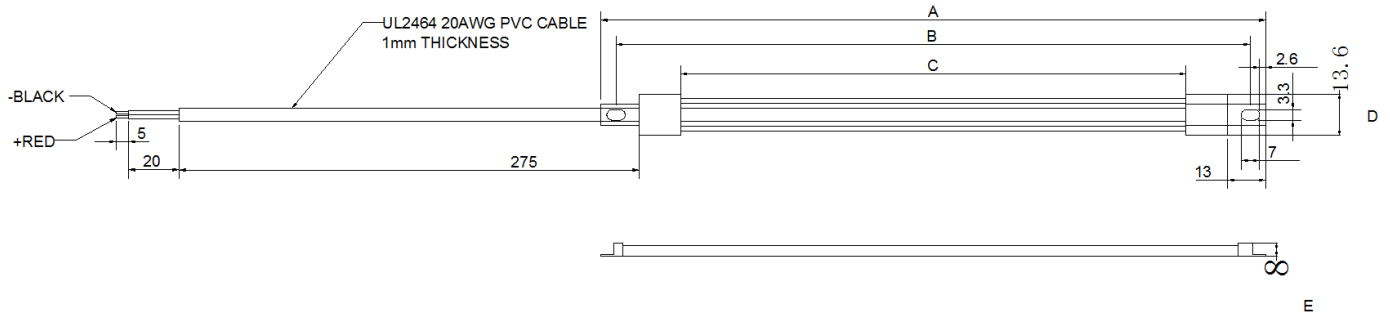

	Dimension
A	1229± 5mm
B	1216± 5mm
C	1180± 5mm
D	13.6± 1mm
E	8± 1mm

4. Product Reliability Test/

Tab 4-1 Light Bar Reliability Test

Test Item/	Test Conditions/	Test Time/	Number Of Test/	Judgement Criterions/
Operat83.7591.96 624.1				



5. Product Materials Performance Test And Method At Ta=25 /

Tab 5-1 Light Bar Materials Performance Test And Method Ta=25

Test Item/	Test Conditions/	Test Methods/
LED Optical-electrical Characteristics/LED	Compliance With Specifications/	Integrating Sphere/
Connector Pull Force/	$\geq 7\text{kgf}$	Notes/
LED Push & Pull Force/ LED	$\geq 3\text{kgf}$	
LED Welding Standards/ LED	Offset Specifications/ X Shift / X $\leq \pm 0.15\text{mm};$ Y Shift/ Y $\leq \pm 0.15\text{mm};$ Angle/ $\leq \pm 3^\circ;$	

Notes

Fig 5-1 Push & Pull Test Equipment

Fig 7-2 Push & Pull Test Method

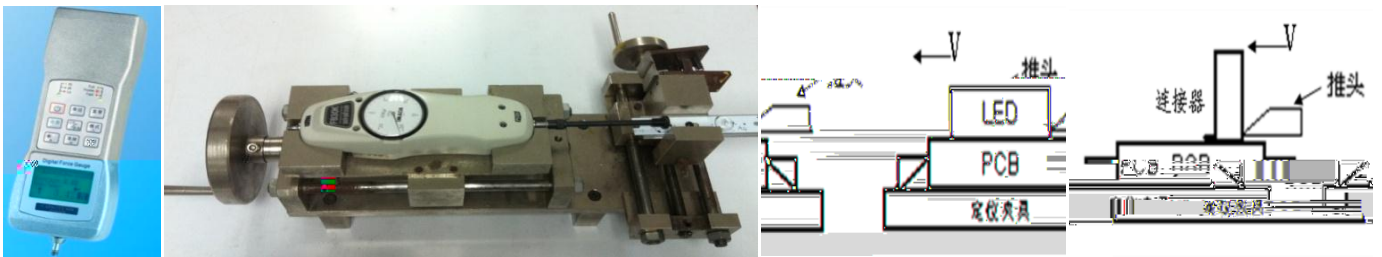

6.Packing Criterion/

6.1 Package Diagram /

Fig 8-1Package Diagram /

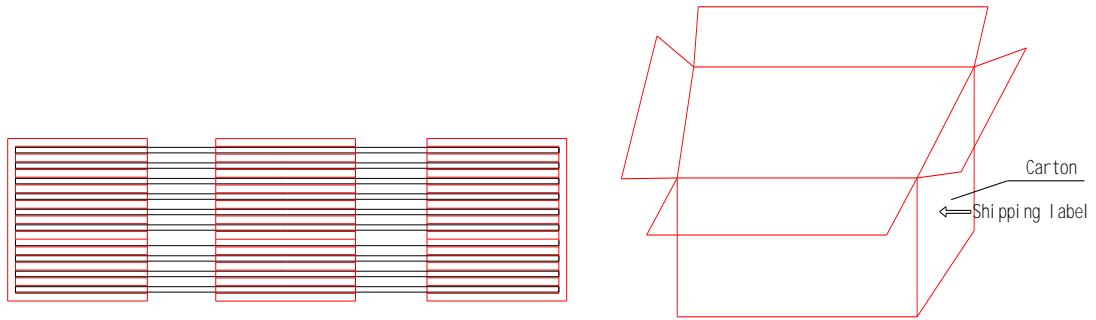

6.2 Carton silk printing/

REFOND LOGOPay attention to identify

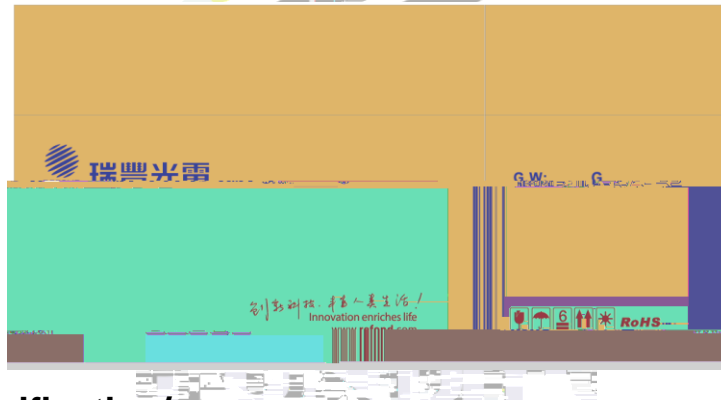

6.3Label Form Specification/

REFOND SHENZHEN REFOND OPTOELECTRONICS CO.,LTD.

customer PN			
/P.N			
/BIN CODE		/LM	
/VF		/CCT	
/CRI		/QTY	
/N.W		/DATE	

7. Handling Precautions

(1) LED operating environment and sulfur element composition cannot be over 100PPM in the LED mating usage material. This is provided for informational purposes only and is not a warranty or endorsement. LED LED 100PPM.

(2) In order to prevent external material from getting into the inside of LED, which may cause the malfunction of LED, the single content of Bromine element is required to be less than 900PPM, the single content of Chlorine element is required to be less than 900PPM, the total content of Bromine element and Chlorine element in the external materials of the application products is required to be less than 1500PPM. This is provided for informational purposes only and is not a warranty or endorsement.

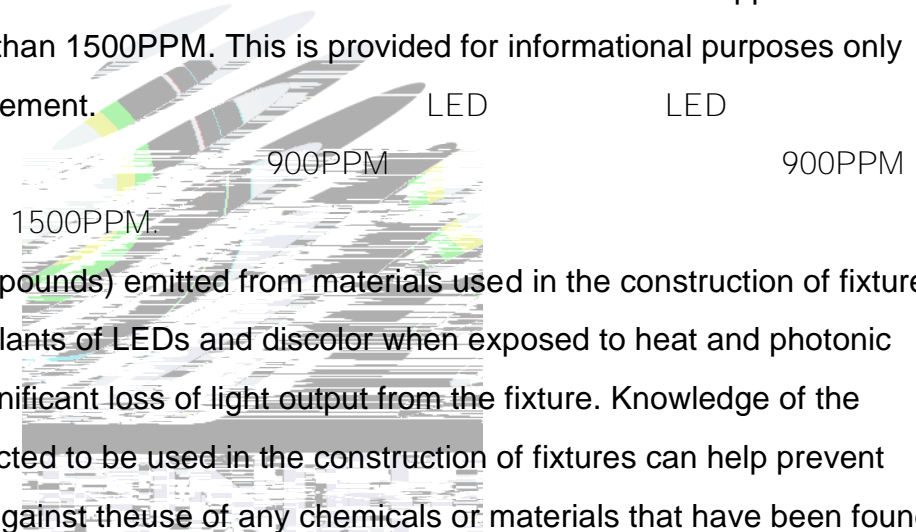

(3) VOCs (Volatile organic compounds) emitted from materials used in the construction of fixtures can penetrate silicone encapsulants of LEDs and discolor when exposed to heat and photonic energy. The result can be a significant loss of light output from the fixture. Knowledge of the properties of the materials selected to be used in the construction of fixtures can help prevent these issues. Refond advises against the use of any chemicals or materials that have been found or are suspected to have an adverse affect on device performance or reliability. To verify compatibility, Refond recommends that all chemicals and materials be tested in the specific application and environment for which they are intended to be used. Attaching LEDs, do not use adhesives that outgas organic vapor. LED

LED

LED

LED

(4) Handle the component along the side surface by using forceps or appropriate tools; do not directly touch or Handle the silicone lens surface, it may damage the internal circuitry.

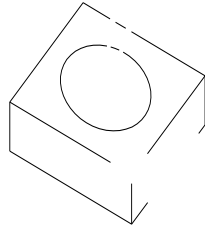

(5) In designing a circuit, the current through each LED cannot be exceeded the absolute maximum rating specified for each LED. In the meanwhile, resistors for protection should be applied, otherwise slight voltage shift will cause big current change, burn out may happen. The driving circuit must be designed to allow forward voltage only when it is ON or OFF. If the reverse voltage is applied to LED, migration can be generated resulting in LED damage.

LED

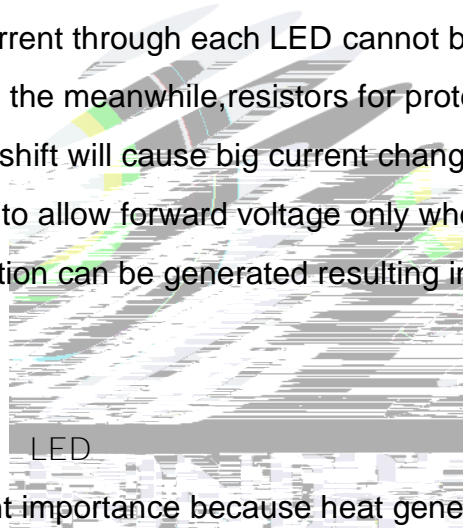

(6) Thermal Design is paramount importance because heat generation may result in the Characteristics decline, such as brightness decreased, Color change and so on. Please consider the heat generation of the LEDs when making the system design. LED

LED

(7) Compared to standard encapsulants, silicone is generally softer, and the surface is more likely to attract dust, requiring special care during processing. In cases where a minimal level of dirt and dust particles cannot be guaranteed, a suitable cleaning solution must be applied to the surface after the soldering of components. Refond suggests using isopropyl alcohol for cleaning. In case other solvents are used, it must be assured that these solvents do not dissolve the package or resin. Ultrasonic cleaning is not recommended. Ultrasonic cleaning may cause

damage to the LED.

LED

(8) Similar to most Solid state devices; LEDs are sensitive to Electro-Static Discharge (ESD) and Electrical Over Stress (EOS).

LED

9>.NO warping or twisting the Light Bar more than 10°. Forbidding holding the LED part or connector part when handling.

10°

LED

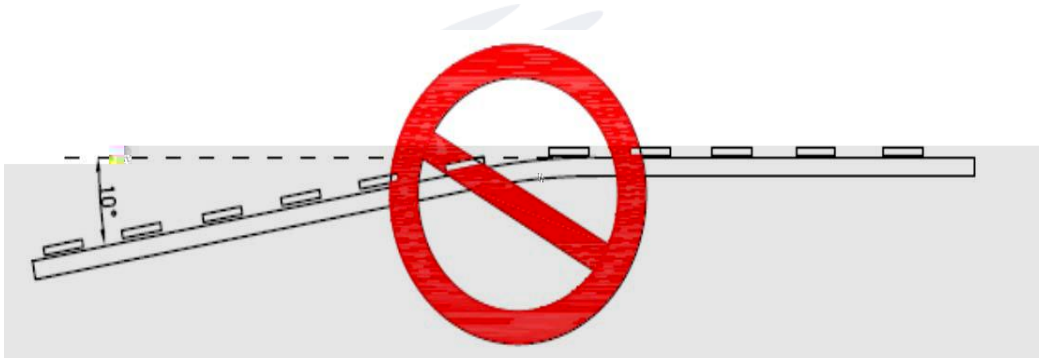

(10) Other points for attention, please refer to our relevant information.

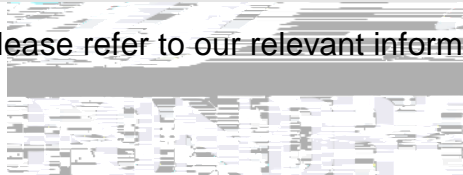



Declare

This specification is written both in English and in Chinese and the latter is formal.