

SPECIFICATION

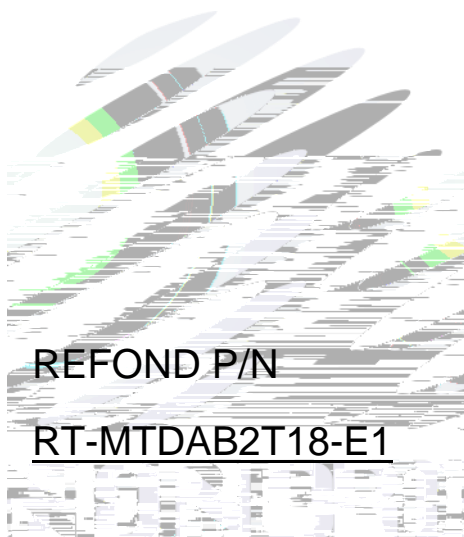

Mass Product

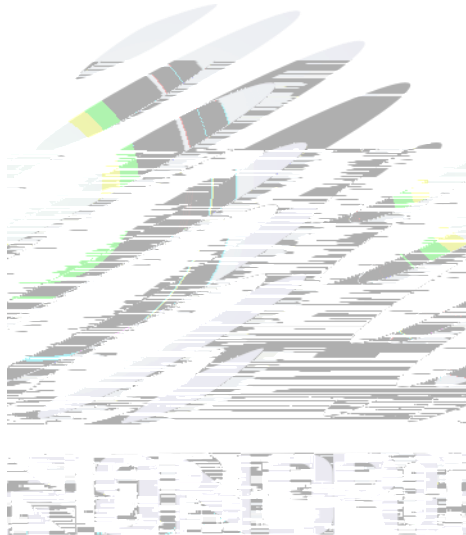

1. LED Module Description

LED Module designed according to the market mainstream of lamps and lanterns, easy to match, assembly is convenient;

不 光



2.LED Module Specification

2.1 Optical-electrical Characteristics(Absolute Maximum Ratings At Ts=25)

Tab.2-1 Optical-electrical Characteristics

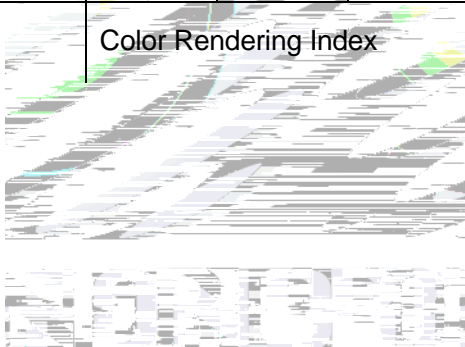
Refond PN	Module Characteristics						
	Current mA	Voltage(V)		Power(W)		Module LM	
	Typ	Min	Max	Min	Max	Min	Max
RT-MTDAB2T18-E1 3500K	360	41.6	52.8	14.976	19.1	2285	2765
RT-MTDAB2T18-E1 5000K	360	41.6	52.8	14.976	19.1	2400	2900
RT-MTDAB2T18-E1 3500&5000K	360	41.6	52.8	14.976	19.1	2525	3060
(I mA)Test condition 360	Color Rendering Index				Min	Max	Typ
					80		

2.2 LED Module Schematic And Interface Definition

Fig.2-2ED Module connection

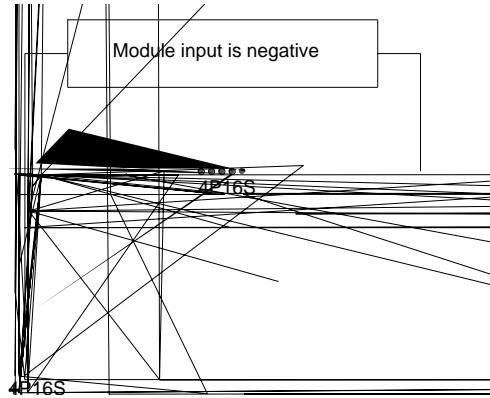

2.3 LED Module rule of naming

RT-MT D AB 2 T 18 - E 1

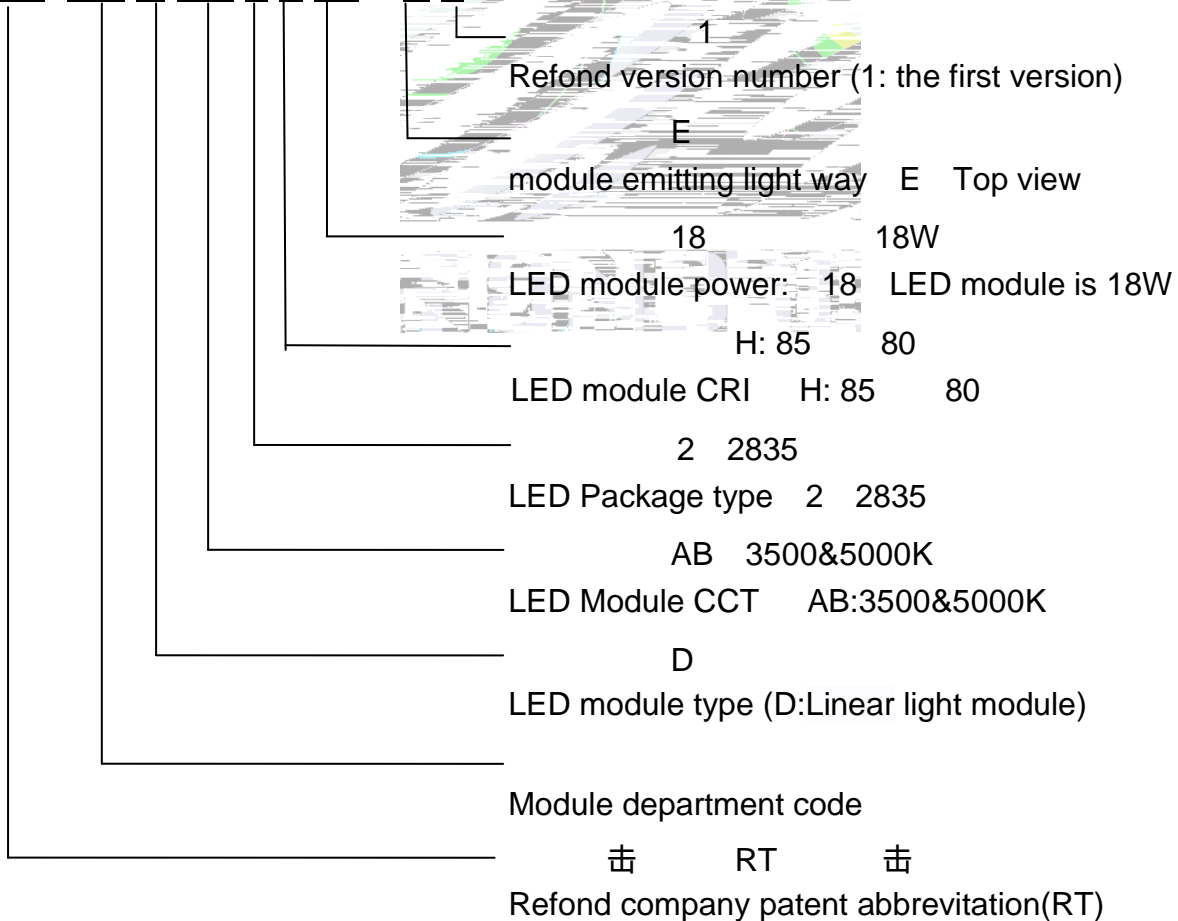

3. Product Specification

3.1 Outline Dimension

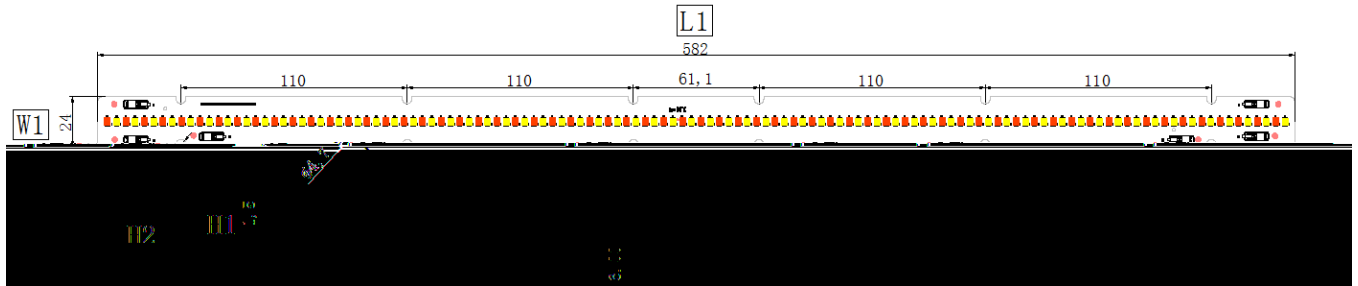

	Dimension	Specification	Tolerance
L	Module Length	582	±0.3
W	Module Width	24	±0.3
H1	PCB Thickness PCB	1.5	±0.16
H2	Height of Module	6	±0.3

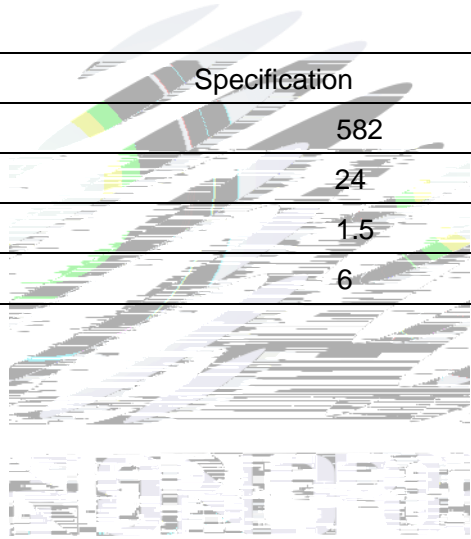

4. LED Module Reliability Test

Tab 4-1 Light Bar Reliability Test

Test Item/	Test Conditions/	Test Time/	Number Of Test/	Judgement Criteria/
Operating Life At Room Temperature/	$T_A=25$ $I_F=360\text{mA}$ $T_J<115$	500Hrs	0/6	1. $7. +$ $V_f<110\%$, $CIE\ x/ y<0.015$ 2.No catastrophic failure
Operating Life At High Temperature/	$T_A=60$ $I_F=360\text{mA}$ $T_J<115$	500Hrs	0/6	
Operating Life At High Temperature And Humidity/	60 $R_H=90\%$ $I_F=360\text{mA}$ $T_J<115$	500Hrs	0/6	
Thermal Shock/	-40 15min , + 85 15min	100 cycle	0/6	No Dead LED

Notes

voltage distribution, heat dissipation and others.

5. LED Module Materials Performance Test And Method At Ta=25

Tab 5-1 Light Bar Materials Performance Test And Method Ta=25

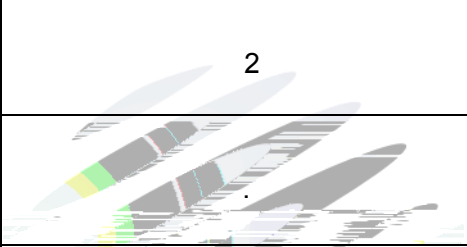
Test Item	Test Conditions	Test Methods
LED Optical-electrical Characteristics LED	Compliance With Specifications/	Integrating Sphere/
Connector Pull Force/		Notes/
LED Push & Pull Force LED		
LED Welding Standards LED	Offset Specifications/	
	X Shift / X +), 0 6 Y Shift / Y +), 0 6 Angle/ . 6	

Notes

Fig 5-1 Push & Pull Test Equipment

Fig 7-2 Push & Pull Test Method

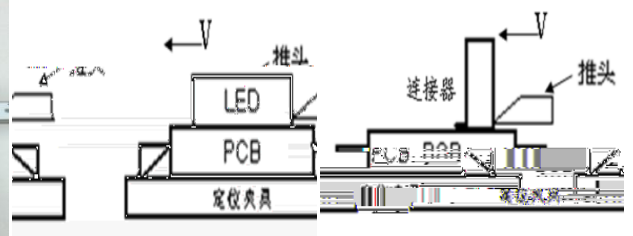
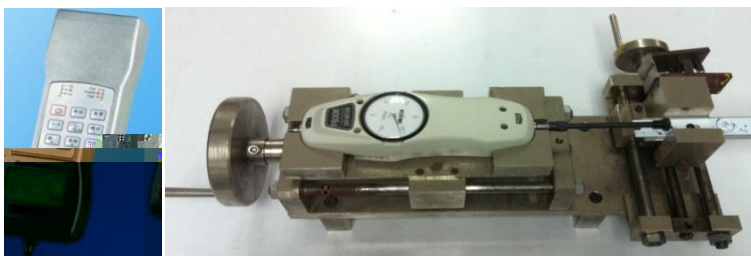

6.Packing Criterion

6.1 Package Diagram /

Fig 8-1 Package Diagram /

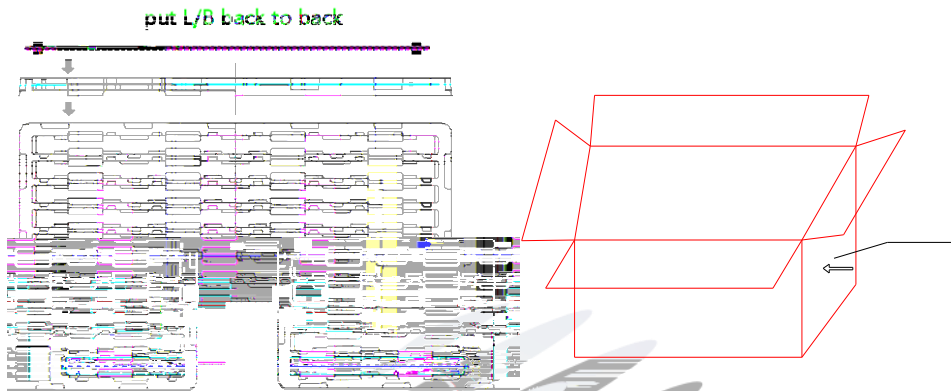

6.2 Blister box Dimensions/

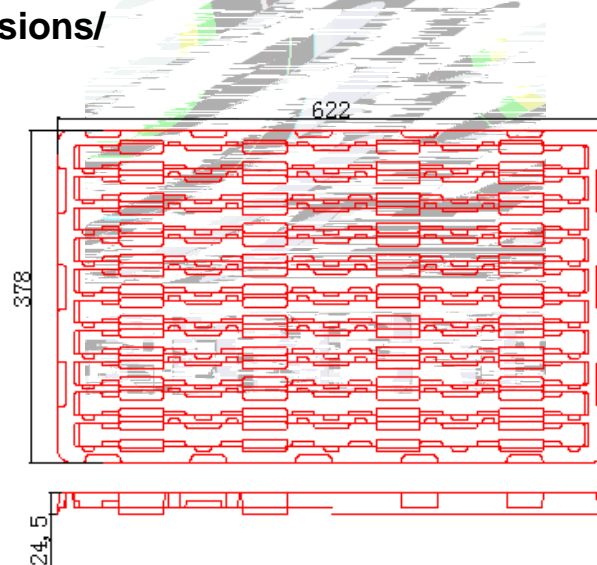

6.3 Carton Dimensions/

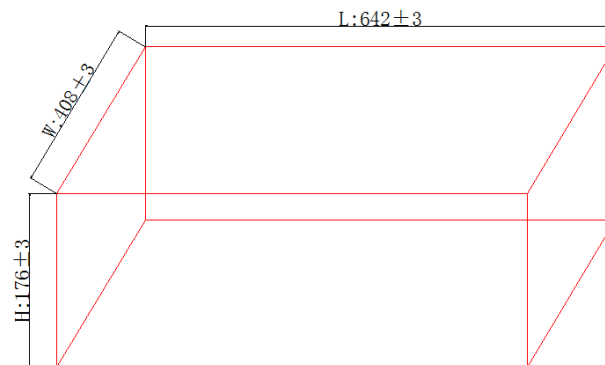

6.4 Carton silk printing/

REFOND LOGO Pay attention to identify

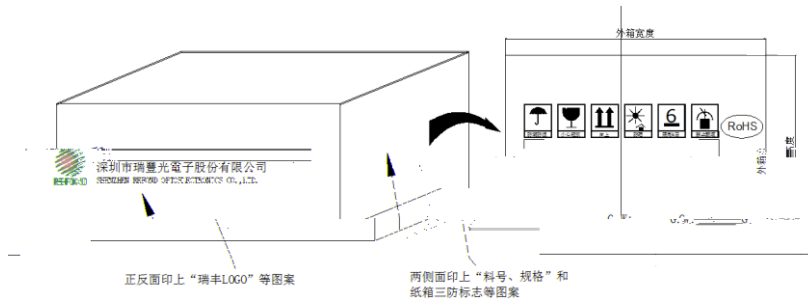

6.5 Label Form Specification/

REFOND SHENZHEN REFOND OPTOELECTRONICS CO.,LTD.

/customer PN			
/P.N			
/BIN CODE		/LM	
/VF		/CCT	
		/QTY	
/N.W		/DATE	

Package quantity(160PCS/carton) "

1. A box of 9 plastic boxes, including 8 plastic ones, has an empty one which is used as a cover to protect the modules underneath.

元

2. Plastic boxes should be put layer by layer with a positive and negative layer stacked together ,a total of 8 layers, and a layer of empty plastic box as protection one is supposed to be put on the top.

元

3. Each plastic box has a total of 20PCS module installed and contains 10 slots, in which 2PCS module should be put back to back.

元

The cartons of the whole box can be subjected to six layers. As for the height of the stack , please make decision based on the actual situation.



(4) Handle the component along the side surface by using forceps or appropriate tools; do not directly touch or Handle the silicone lens surface, it may damage the internal circuitry.

光

们

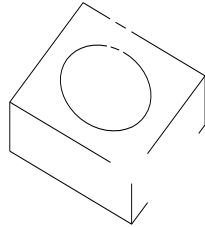

(5) In designing a circuit, the current through each LED can not be exceed the absolute maximum rating specified for each LED. In the mean while, resistors for protection should be applied, otherwise slight voltage shift will cause big current change, burn out may happen. The driving circuit must be designed to allow forward voltage only when it is ON or OFF. If the reverse voltage is applied to LED, migration can be generated resulting in LED damage.

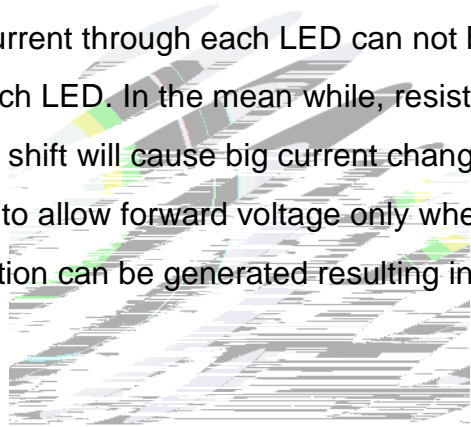

们

充

们

(6) Thermal Design is paramount importance because heat generation may result in the Characteristics decline, such as brightness decreased, Color change and so on. Please consider the heat generation of the LEDs when making the system design.LED

们

(7) Compared to standard encapsulants, silicone is generally softer, and the surface is more likely to attract dust , requiring special care during processing. In cases where a minimal level of dirt and dust particles cannot be guaranteed, a suitable cleaning solution must be applied to the surface after the soldering of components. Refond suggests using isopropyl alcohol for cleaning. In case other solvents are used, it must be assured that these solvents do not dissolve the package or resin. Ultrasonic cleaning is not recommended. Ultrasonic cleaning may cause

damage to the LED.

们 们

(8) Similar to most Solid state devices; LEDs are sensitive to Electro-Static Discharge (ESD) and Electrical Over Stress (EOS).

9>.NO warping or twisting the Light Bar more than 10°. Forbidding holding the LED part or connector part when handling.

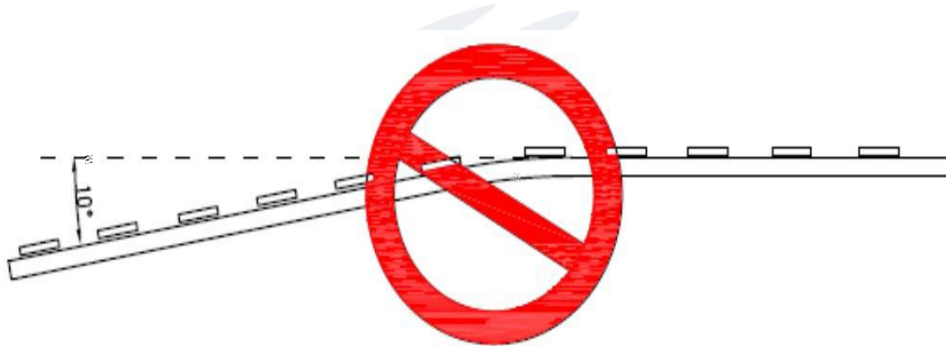

(10) Other points for attention, please refer to our relevant information.

充

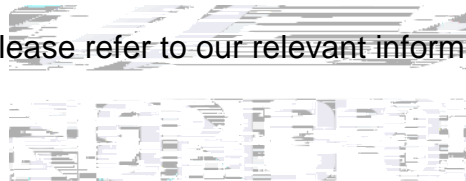



Declare

This specification is written both in English and in Chinese and the latter is formal.