

SPECIFICATION



Contents

1. Description

| | | |
|-------------------------|-------|---|
| 1.1 General Description | | 3 |
| 1.2 Features | | 3 |
| 1.3 Application | | 3 |



1. Description

1.1 General Description



This production has a high reliability, good heat dissipation, are widely used in the disinfection, phototherapy, sensor light, Bio-Analysis/Detection, Counterfeit Detectors, etc.

1.2 Features

Size(mm):3.7*3.7*1.8.

Viewing angle:120° .

Suitable for all SMT assembly and solder process.

Available on tape and reel.

Moisture sensitivity level: Level 3.

RoHS compliant.

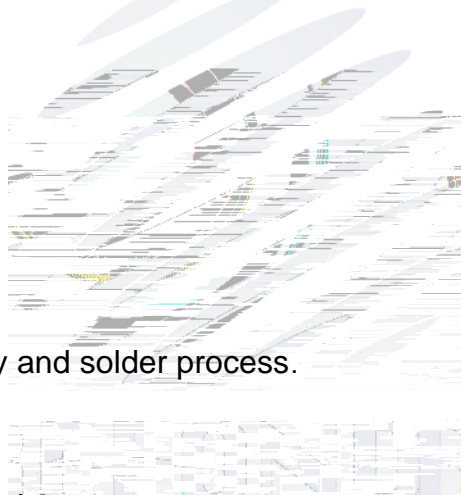

1.3 Application

Ultraviolet disinfection.

Phototherapy.

Bio-Analysis/Detection.

General use.

1.4 Package Dimension

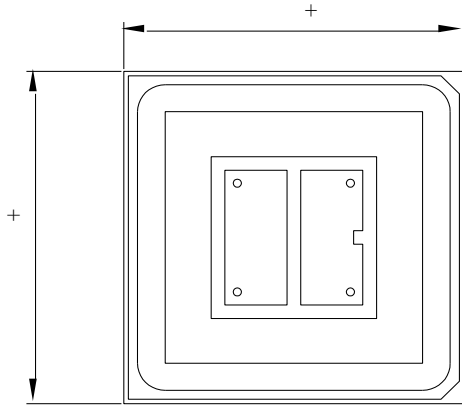

Fig.1-1 Top view



Fig.1-2 Side view

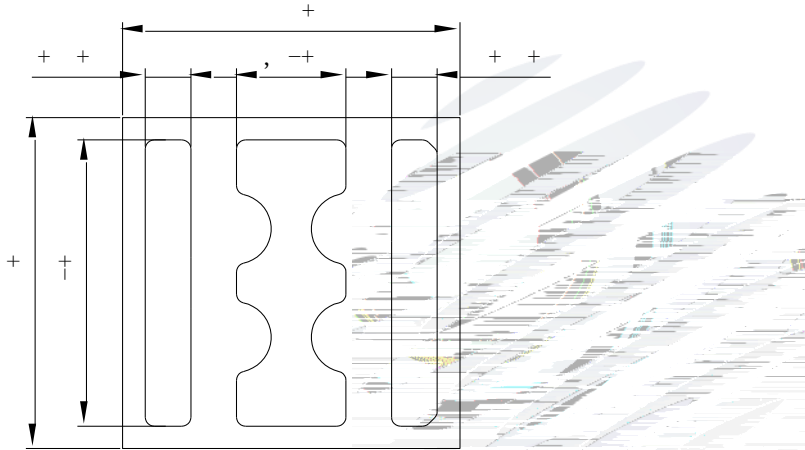

Fig.1-3 Bottom view

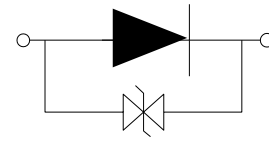

Fig.1-4 Polarity

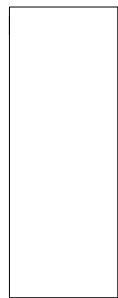

Fig.1-5 Soldering patterns

Notes

All dimensions units are millimeters.

All dimensions tolerances are $\pm 0.2\text{mm}$ unless otherwise noted.

1.5 Product Parameters

Table 1-1 Electrical / Optical Characteristics at Ts=25°C

| Item | Symbol | Test Condition | Code | Value | | | Unit |
|---------------------|--------------------|-----------------------|------|-------|-----|------|------|
| | | | | Min. | Typ | Max. | |
| Forward Voltage | V _F | I _F =150mA | B16 | 4.0 | --- | 4.2 | V |
| | | | B17 | 4.2 | --- | 4.4 | |
| | | | B18 | 4.4 | --- | 4.6 | |
| | | | B19 | 4.6 | --- | 4.8 | |
| | | | B20 | 4.8 | --- | 5.0 | |
| | | | B21 | 5.0 | --- | 5.2 | |
| | | | B22 | 5.2 | --- | 5.4 | |
| | | | B23 | 5.4 | --- | 5.6 | |
| | | | B24 | 5.6 | --- | 5.8 | |
| | | | B25 | 5.8 | --- | 6.0 | |
| | | | B26 | 6.0 | --- | 6.2 | |
| B27 | 6.2 | --- | 6.4 | | | | |
| Reverse Current | I _R | V _R =10V | --- | --- | --- | 5 | uA |
| Total radiant flux | e | I _F =150mA | 1J04 | 10 | --- | 15 | mW |
| | | | 1J05 | 15 | --- | 20 | |
| Peak wavelength | | I _F =150mA | UA42 | 305 | --- | 310 | nm |
| | | | UA43 | 310 | 311 | 315 | |
| Spectrum Half width | | I _F =150mA | --- | 10 | 13 | 15 | nm |
| Viewing Angle | | I _F =150mA | --- | --- | 120 | --- | deg |
| Thermal Resistance. | R _{THJ-S} | I _F =150mA | --- | --- | 45 | --- | /W |

Table 1-2 Absolute Maximum Ratings at Ts=25°C

Notes

1. 1/10 Duty cycle, 0.1ms pulse width.
2. The above forward voltage measurement allowance tolerance is $\pm 0.1V$.
3. The above wavelength measurement allowance tolerance is $\pm 2nm$.
4. The above radiation flux measurement allowance tolerance $\pm 10\%$.

±



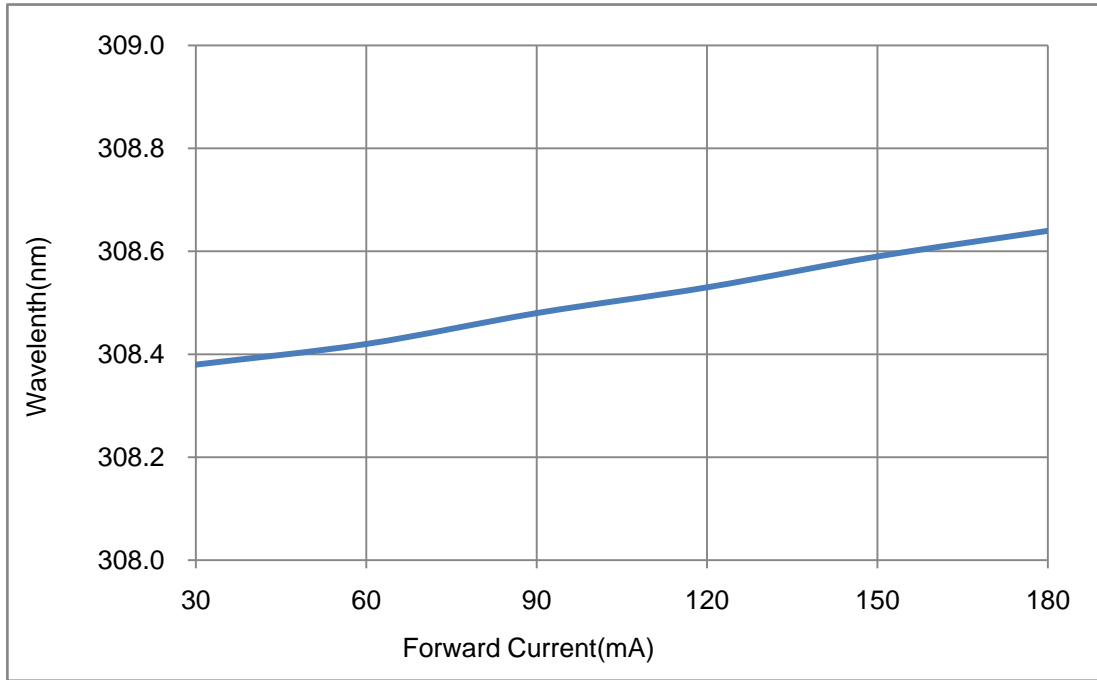

Fig.3- Peak Wavelength Vs. Forward Current

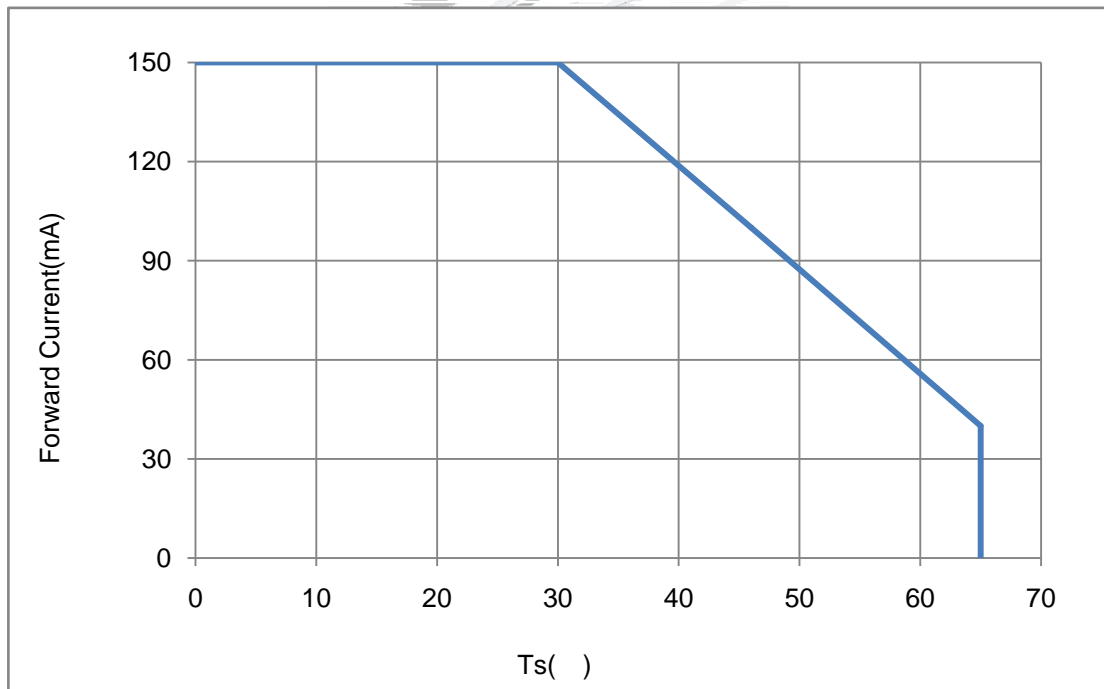
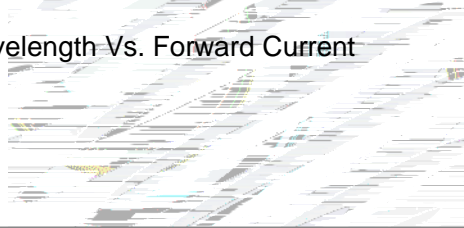

Fig.4-Ts Temperature VS. Forward Current

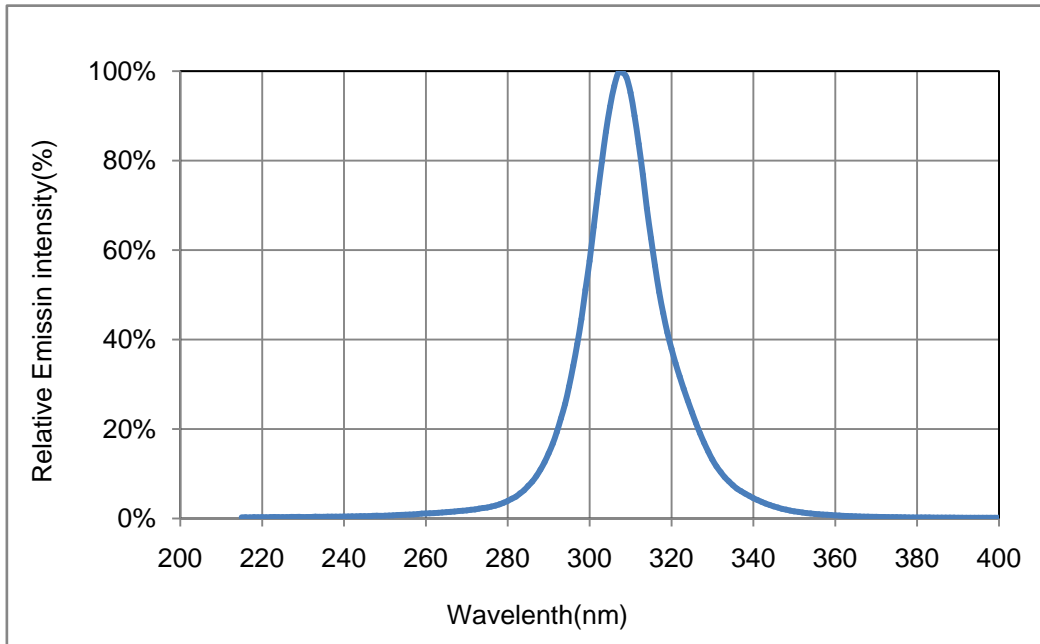

Fig.5-Spectrum Distribution

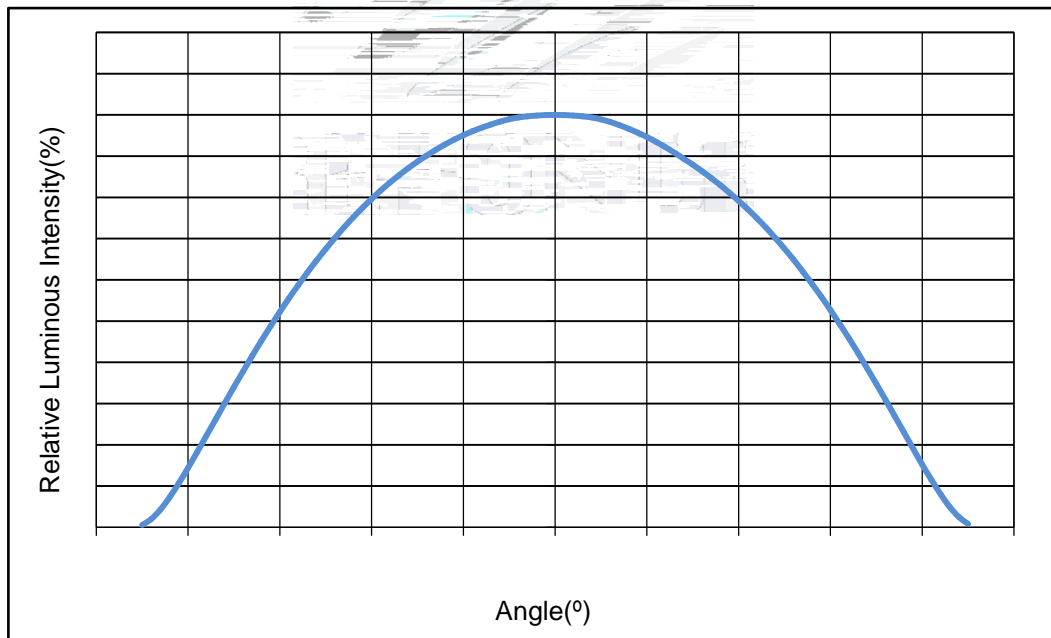

Fig.6- Radiation Diagram

2. Packaging

2.1 Packaging Specification

Package:1000pcs/reel.

2.1.1 Carrier Tape Dimension

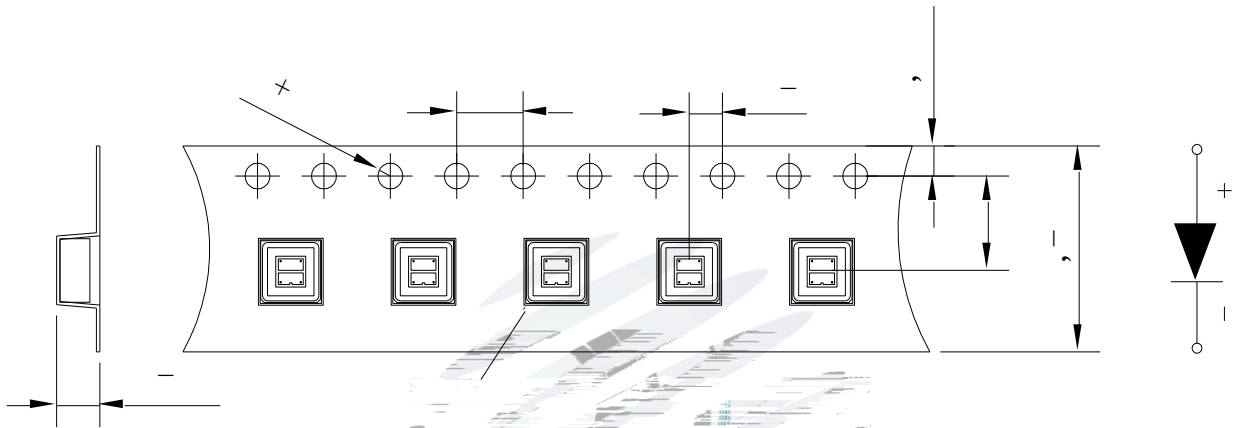
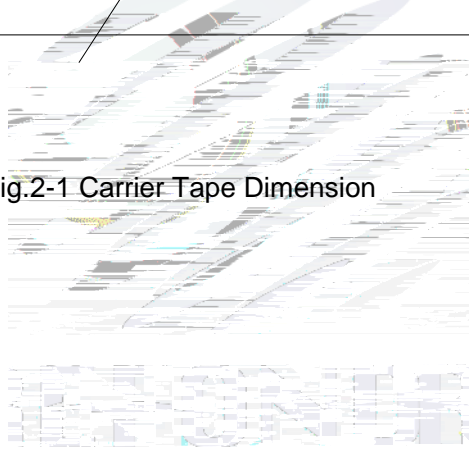

Fig.2-1 Carrier Tape Dimension

2.1.2 Reel Dimension



2.1.3 Label Form Specification

Label Form Specification

PART NO. Part Number

Fig. 2-3 Label Form Specification

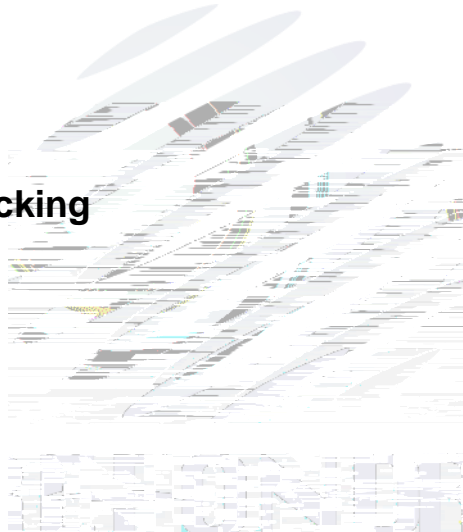

2.2 Moisture Resistant Packing

Fig.2-4 Moisture Resistant Packing Process

2.3 Cardboard Box

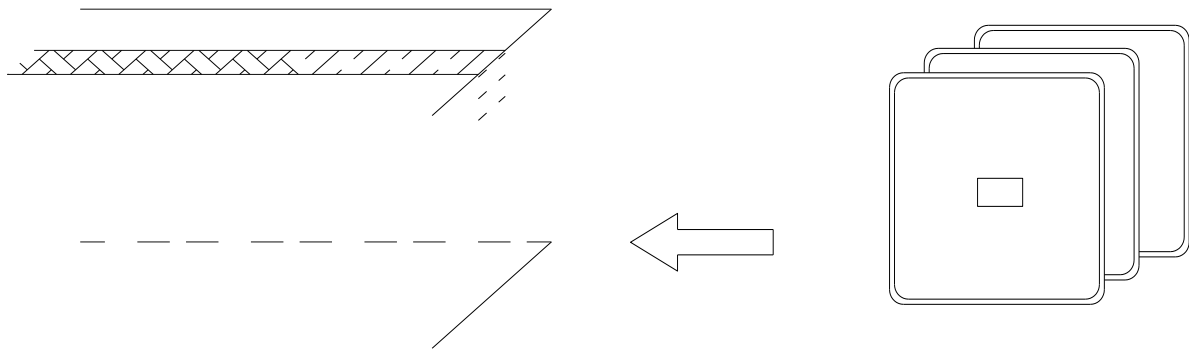

Fig.2-5 Cardboard Box

2.4 Reliability Test Items And Conditions

Table 2-3 Reliability Test Items And Conditions

| Test Items | Ref.Standard | Test Condition | Time | Quantity | Ac/Re |
|---------------|--------------|---|------------|----------|-------|
| Reflow | JESD22-B106 | Temp:260 max T=10 sec | 3times. | 10Pcs. | 0/1 |
| Thermal Shock | JESD22-A106 | -40 15min 100 15min | 100 Cycles | 10Pcs. | 0/1 |
| Life Test | JESD22-A108 | T _a =25 I _f =150mA | 1000Hrs. | 10Pcs. | 0/1 |

2.5 Criteria For Judging Damage

Table 2-4 Criteria For Judging Damage

| Test Items | Symbol | Test Condition |
|------------|--------|----------------|
|------------|--------|----------------|



3. SMT Reflow Soldering Instructions SMT 5Dyf

3.1 SMT Reflow Soldering Instructions SMT

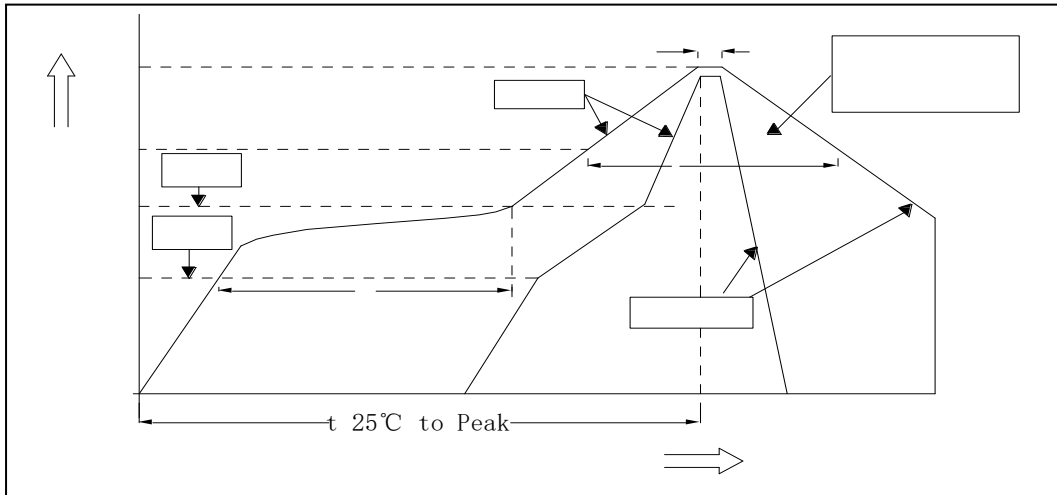

Fig.3-1 SMT Reflow Soldering Instructions

Table 3-1 SMT Reflow Soldering Instructions

| | | |
|---|-----------------------------------|-------------------|
| Average temperature rise speed | T _{max} T _P | Max 3 °C/ s 3 °C/ |
| Preheating: minimum temperature | (T _{min}) | 150 °C |
| Preheating: Max temperature | (T _{max}) | 200 °C |
| Preheating: Time | T _{min} T _{max} | 60s-120s 60 - 120 |
| Time limited to maintain high temperature: the temperature (T _L) | | 217 °C |
| Time limited to maintain high temperature: The Time (t _L) | | Max 60s 60 |
| Peak /Classification of temperature: / (T _P) | | 260 °C |
| Time limit classification of peak temperature time t _p | | Max 10s 10 |
| Hold time within 5 °C with the actual peak temperature (T _P) (T _P) 5 °C | | Max 30s 30 |
| Cooling speed | | Max 6 °C/ s 6 °C/ |
| Needed time from 25 °C to T _p 25 °C | | Max 8 minutes 8 |

Notes

(1) Reflow soldering should not be done more than twice. If more than 24 hours between the two solderings, LED will be damaged.

(2) When soldering, do not put stress on the LEDs during heating.

3.1.1 Soldering Iron

(1) When do soldering by hand, keep the temperature of iron below less 300 less than 3 seconds

(2) Soldering by hand should be done only one time.

3.1.2 Repairing

Repairing should not be done after the LEDs have been soldered. When repairing is unavoidable, a double-head soldering iron should be used (as below figure). It should be confirmed in advance whether the characteristics of LEDs will or not be damaged by repairing.

LED

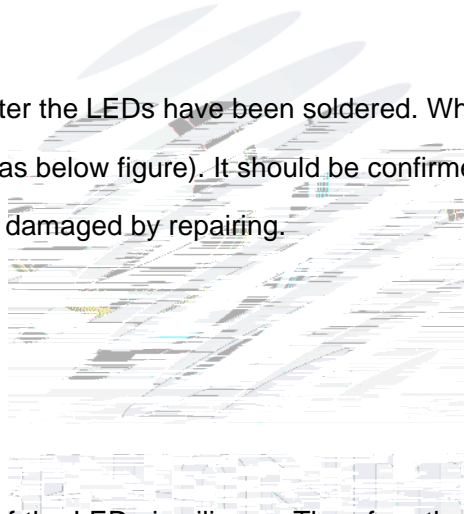

3.1.3 Cautions

(1) The encapsulated material of the LEDs is silicone. Therefore the LEDs have a soft surface on the top of package. The pressure to the top surface will be impacted on the reliability of the LEDs. Precautions should be taken to avoid the strong pressure on the encapsulated part. So when use the picking up nozzle, the pressure on the silicone resin should be proper. LED

(2) Components should not be mounted on warped (non coplanar) portion of PCB. After soldering, do not warp the circuit board. LED

(3) Do not apply mechanical force or excess vibration during the cooling process to normal temperature after soldering. Do not rapidly cool device after soldering.

4. Handling Precautions

4.1 Handling Precautions

(1) LED operating environment and sulfur element composition cannot be over 100PPM in the LED mating usage material. This is provided for informational purposes only and is not a warranty or endorsement. LED

(2) In order to prevent external material from getting into the inside of LED, which may cause the malfunction of LED, the single content of Bromine element is required to be less than 900PPM, the single content of Chlorine element is required to be less than 900PPM, the total content of Bromine element and Chlorine element in the external materials of the application products is required to be less than 1500PPM. This is provided for informational purposes only and is not a warranty or endorsement.

(3) VOCs (Volatile organic compounds) emitted from materials used in the construction of fixtures can penetrate silicone encapsulants of LEDs and discolor when exposed to heat and photonic energy. The result can be a significant loss of light output from the fixture. Knowledge of the properties of the materials selected to be used in the construction of fixtures can help prevent these issues. Refond advises against the use of any chemicals or materials that have been found or are suspected to have an adverse effect on device performance or reliability. To verify compatibility, Refond recommends that all chemicals and materials be tested in the specific application and environment for which they are intended to be used. Attaching LEDs, do not use adhesives that outgas organic vapor.

(4) Handle the component along the side surface by using forceps or appropriate tools; Do not directly touch or Handle the silicone lens surface, it may damage the internal circuitry.

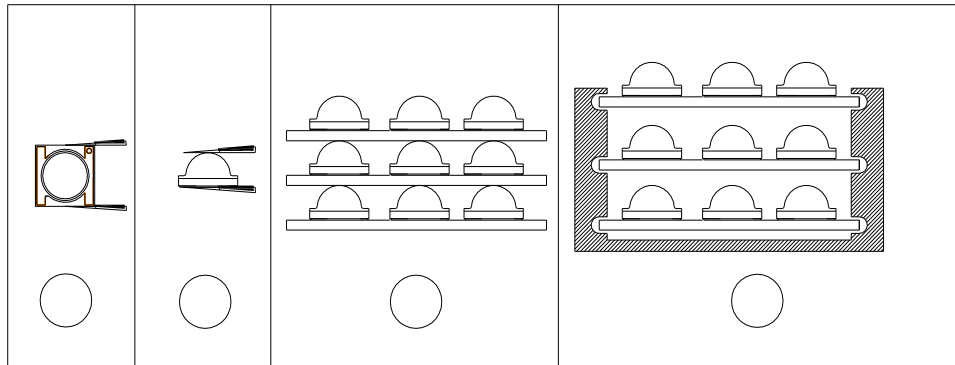

Fig 4-1 Operate Method

(5) In designing a circuit, the current through each LED can not exceed the absolute maximum rating specified for each LED. In the meanwhile, resistors for protection should be applied, otherwise slight voltage shift will cause big current change, burn out may happen. The driving circuit must be designed to allow forward voltage only when it is ON or OFF. If the reverse voltage is applied to LED, migration can be generated resulting in LED damage.

(6) Thermal Design is paramount importance because heat generation may result in the Characteristics decline, such as brightness decreased, lifetime, Color change and so on. Please consider the heat generation of the LEDs when making the system design. LED

(7) Compared to standard encapsulants, silicone is generally softer, and the surface is more likely to attract dust, requiring special care during processing. In cases where a minimal level of dirt and dust particles cannot be guaranteed, a suitable cleaning solution must be applied to the surface after the soldering of components. Refond suggests using isopropyl alcohol for cleaning. In case other solvents are used, it must be assured that these solvents do not dissolve the package or resin. Ultrasonic cleaning is not recommended. Ultrasonic cleaning may cause damage to the LED.

Table 4-1 Storage

| Conditions | | Temperature | Humidity | Time |
|------------|-----------------------------|-------------|----------|-------------------------|
| Storage | Before Opening Aluminum Bag | 30 | 75% | Within 1 Year From Date |
| | After Opening Aluminum Bag | 30 | 60% | 24hours 24 |
| Baking | | 60 5 | - | 24hours 24 |

(8) If the moisture absorbent material silica gel has faded away or the LEDs have exceeded the storage time, baking treatment should be performed after unpacking and based on the following condition 65 5 for above 24 hours.

If the package is flatulence or damaged, please notify the sales staff to assist.

(9) Similar to most Solid state devices; LEDs are sensitive to Electro-Static Discharge (ESD) and Electrical Over Stress (EOS).

(10) When using this product, you need to take good care to prevent it from causing harm to eyes and human body.

(11) Other points for attention, please refer to our relevant information.

Version History/

| Date | Revisor | Version | Verifier | Remarks |
|------------|---------|---------|----------|---------|
| 2020-09-20 | | E0 | | |
| 2021-03-10 | | E1 | | |
| | | | | |
| | | | | |
| | | | | |
| | | | | |
| | | | | |
| | | | | |
| | | | | |
| | | | | |
| | | | | |
| | | | | |
| | | | | |
| | | | | |
| | | | | |
| | | | | |
| | | | | |
| | | | | |
| | | | | |
| | | | | |
| | | | | |



Declare

This specification is written both in English and in Chinese and the latter is formal.