

SPECIFICATION

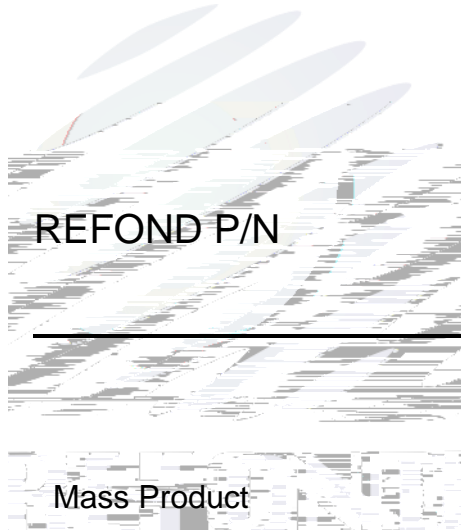



1. Description

1.1 General Description

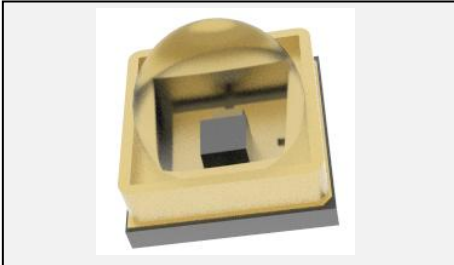

This production has a high reliability, good heat dissipation, are widely used in the disinfection, uv sterilization, Air purification, etc.

1.2 Features

Size(mm):3.7*3.7*3.45.

Viewing angle:60° .

Suitable for all SMT assembly and solder process.

Available on tape and reel.

Moisture sensitivity level: Level 3.

RoHS compliant.

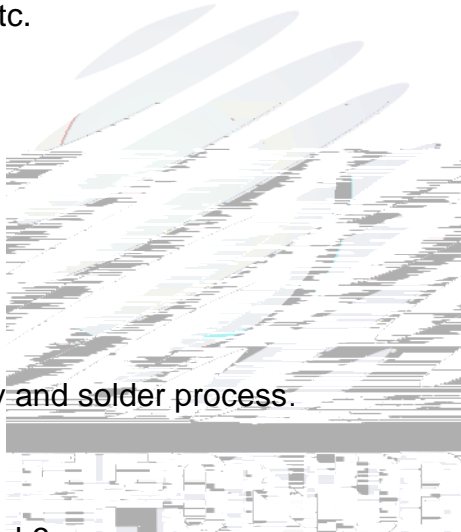

1.3 Application

Ultraviolet disinfection.

UV sterilization.

Air purification.

General use.

1.4 Package Dimension

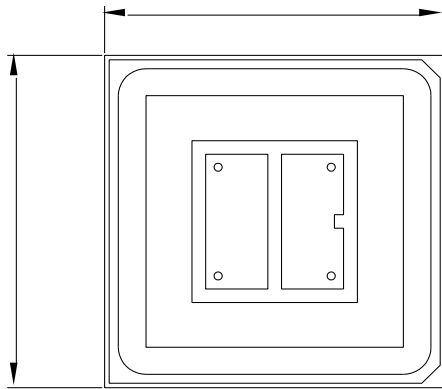

Fig.1-1 Top view

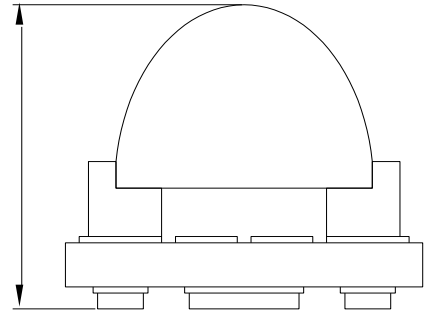

Fig.1-2 Side view

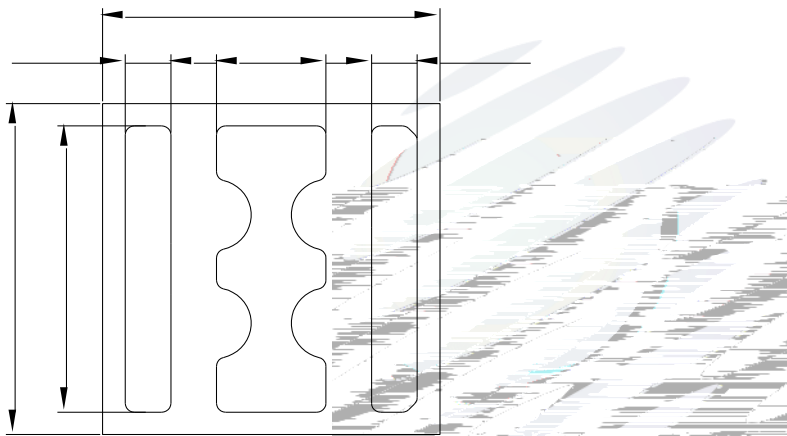

Fig.1-3 Bottom view

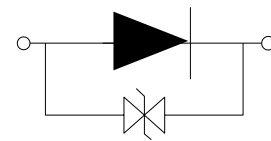

Fig.1-4 Polarity

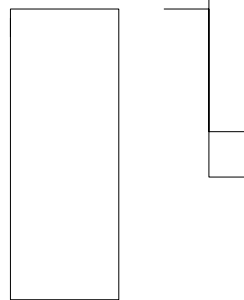

Fig.1-5 Soldering patterns

Notes

All dimensions units are millimeters.

All dimensions tolerances are $\pm 0.2\text{mm}$ unless otherwise noted.

1.5 Product Parameters

Table 1-1 Electrical / Optical Characteristics at Ts=25°C

Item	Symbol	Test Condition	Code	Value			Unit
				Min.	Typ	Max.	
Forward Voltage	V _F	I _F =150mA	B19	4.6	---	4.8	V
			B20	4.8	---	5.0	
			B21	5.0	---	5.2	
			B22	5.2	---	5.4	
			B23	5.4	---	5.6	
			B24	5.6	---	5.8	
			B25	5.8	---	6.0	
			B26	6.0	---	6.2	
			B27	6.2	---	6.4	
			B28	6.4	---	6.6	
			B29	6.6	---	6.8	
			B30	6.8	---	7.0	
			B31	7.0	---	7.2	
			B32	7.2	---	7.4	
B33	7.4	---	7.6				
Reverse Current	I _R	V _R =10V	---	---	---	5	uA
Total radiant flux	e	I _F =150mA	1J03	6	---	10	mW
			1J04	10	14	15	
			1J04	15	---	20	
Peak wavelength		I _F =150mA	UA33	260	---	265	nm
			UA34	265	---	270	
Spectrum Half width		I _F =150mA	---	8	10	12	nm
Viewing Angle							

Table 1-2 Absolute Maximum Ratings at Ts=25°C

Notes

1. 1/10 Duty cycle, 0.1ms pulse width.
2. The above forward voltage measurement allowance tolerance is $\pm 0.1V$.
3. The above wavelength measurement allowance tolerance is $\pm 2nm$.
4. The above radiation flux measurement allowance tolerance $\pm 10\%$.

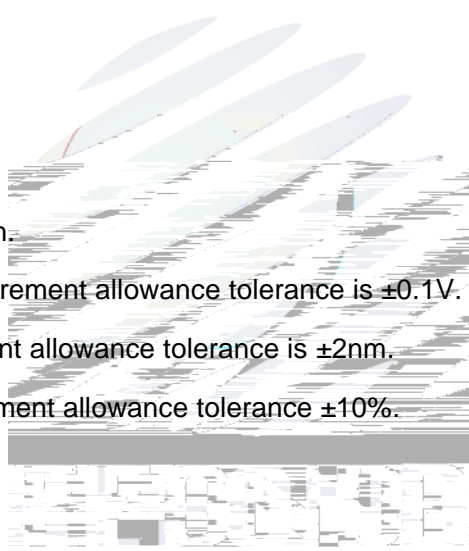

±



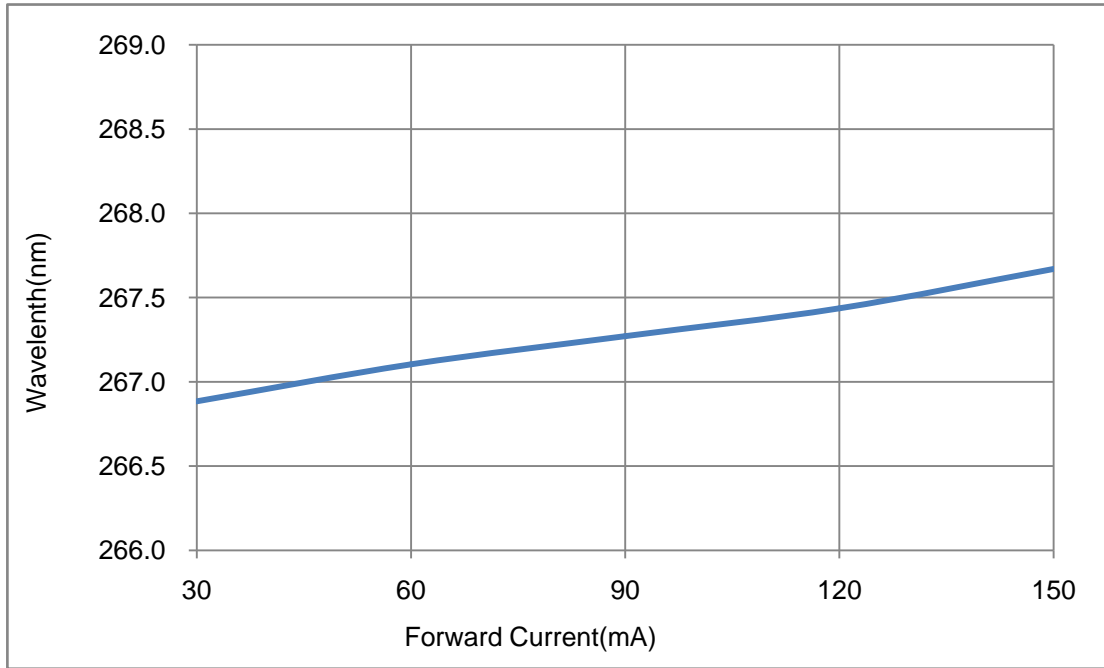

Fig.3- Peak Wavelength Vs. Forward Current

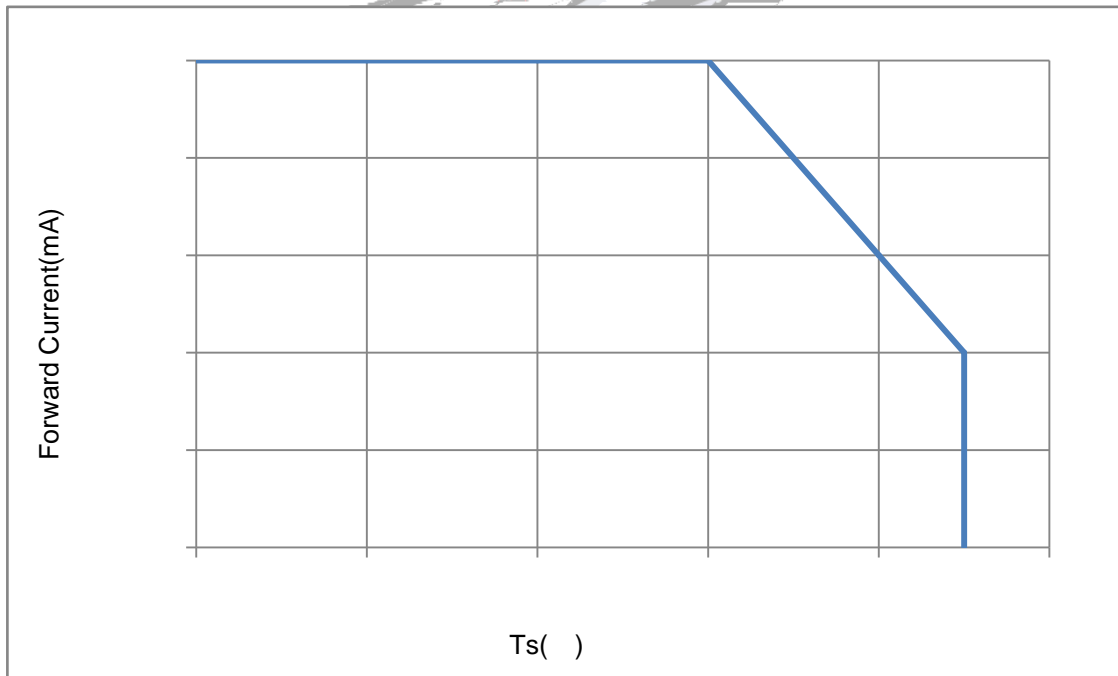

Fig.4-Ts Temperature VS. Forward Current

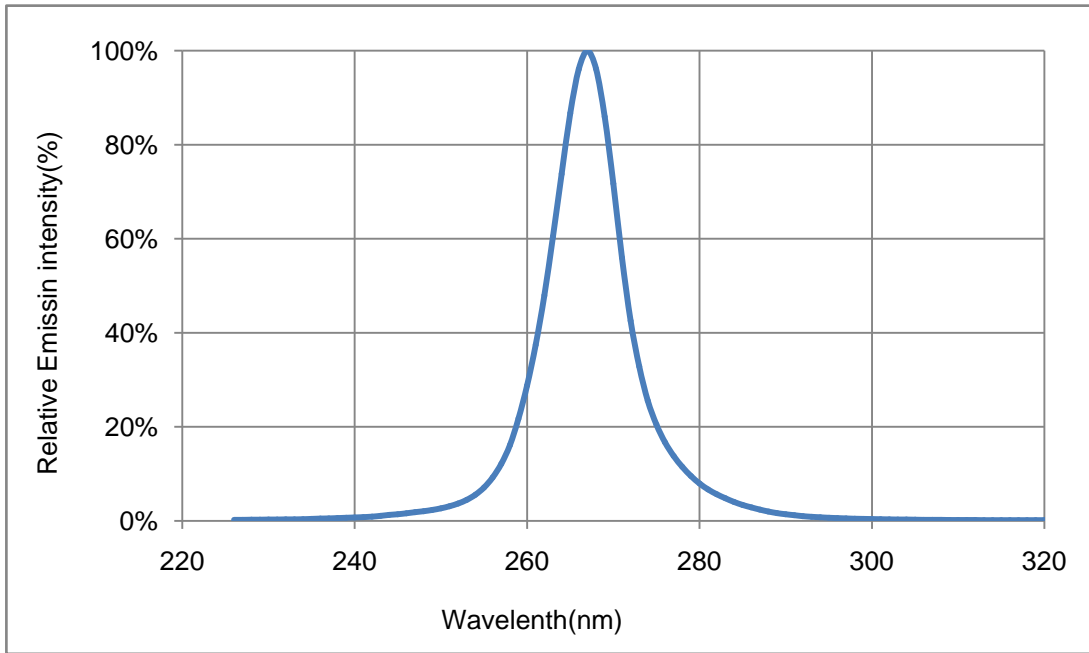

Fig.5-Spectrum Distribution

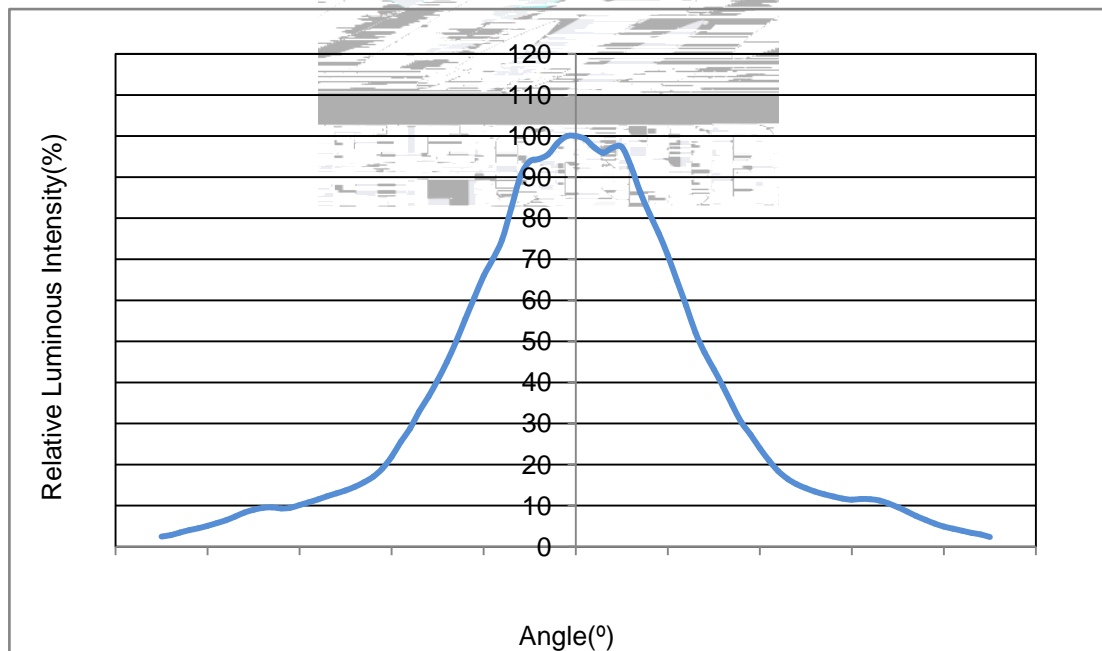

Fig.6- Radiation Diagram

2. Packaging

2.1 Packaging Specification

Package:500pcs/reel.

2.1.1 Carrier Tape Dimension

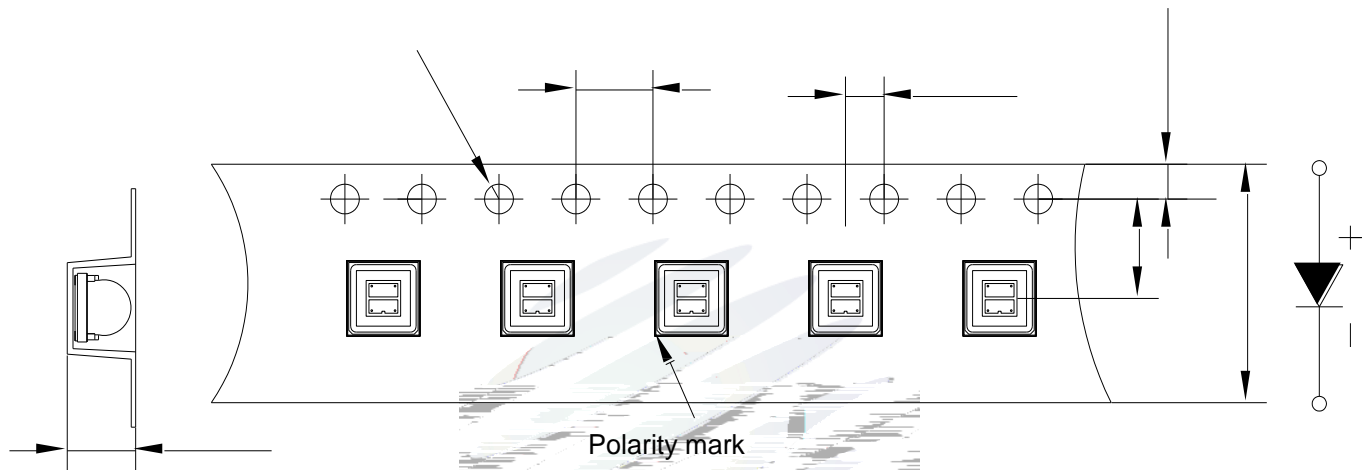
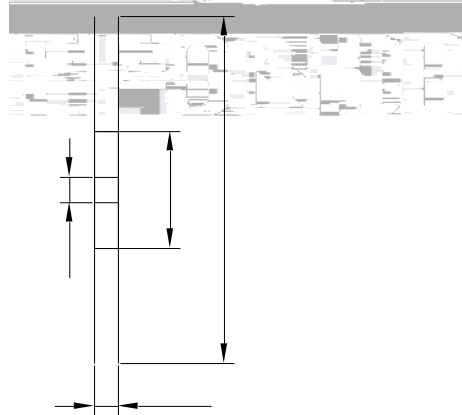
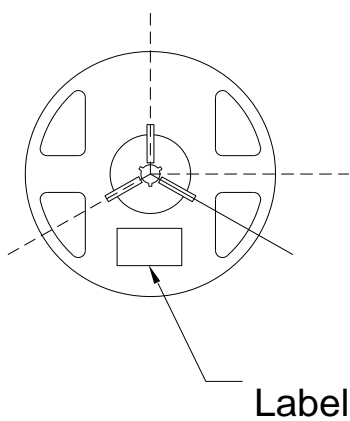

Fig.2-1 Carrier Tape Dimension

2.1.2 Reel Dimension



Reel Dimension

A	12 0.1mm
B	178 1mm
C	60 1mm
D	13.0 0.5mm

Fig.2-2 Reel Dimension

Notes

The tolerances unless mentioned $\pm 0.1\text{mm}$. Unit : mm

2.1.3 Label Form Specification

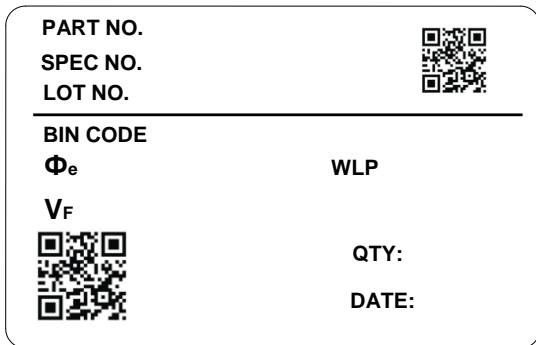

Fig. 2-3 Label Form Specification

Label Form Specification

PART NO.	Part Number
SPEC NO.	Spec Number
LOT NO.	Lot Number
BIN CODE	Bin Code
Φ_e	Radiation flux
V_F	Forward Voltage
WLP	Wavelength
QTY	Packing Quantity
DATE	Made Date

2.2 Moisture Resistant Packing

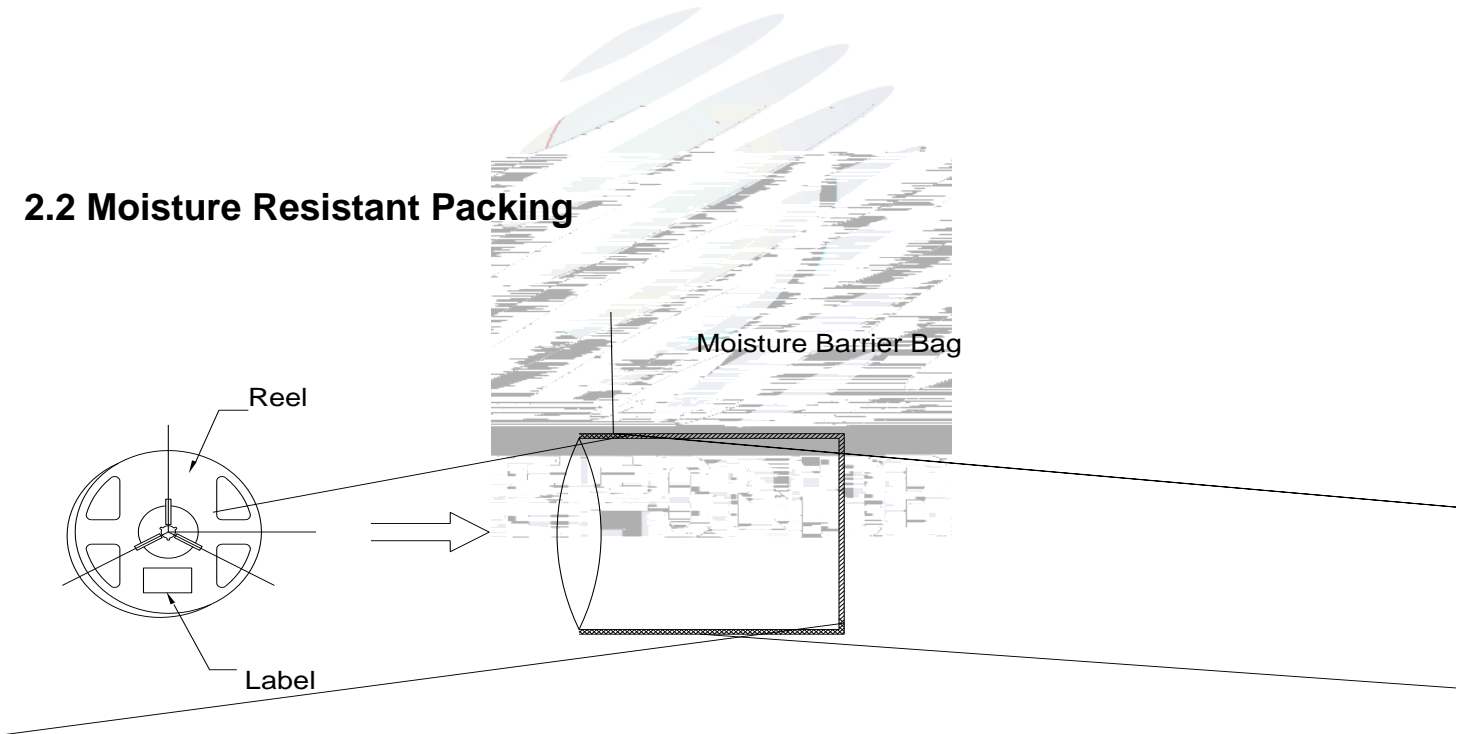

Fig.2-4 Moisture Resistant Packing Process

2.3 Cardboard Box

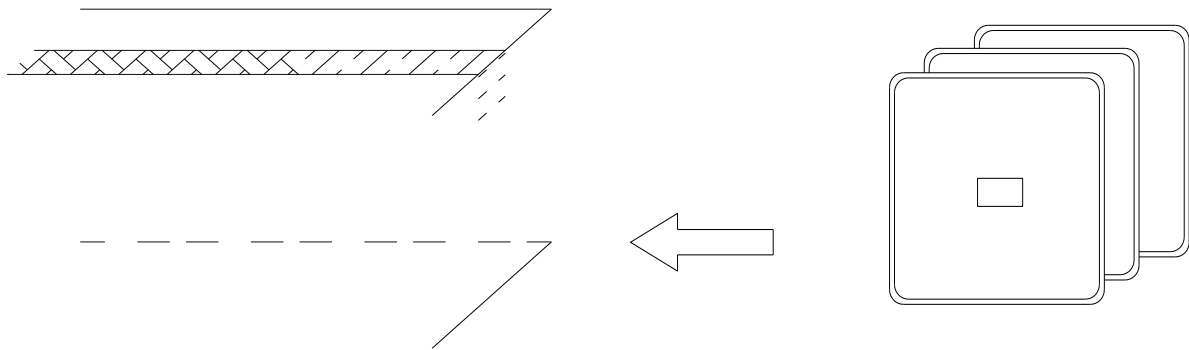

Fig.2-5 Cardboard Box

2.4 Reliability Test Items And Conditions

Table 2-3 Reliability Test Items And Conditions

Test Items	Ref.Standard	Test Condition	Time	Quantity	Ac/Re
Reflow	JESD22-B106	Temp:260 max T=10 sec	3times.	10Pcs.	0/1
Thermal Shock	JESD22-A106	-40 15min 100 15min	100 Cycles	10Pcs.	0/1
Life Test	JESD22-A108	T _a =25 I _f =150mA	1000Hrs.	10Pcs.	0/1

2.5 Criteria For Judging Damage

Table 2-4 Criteria For Judging Damage

Test Items	Symbol	Test Condition	Criteria For Judgement	
			Min.	Max.
Forward Voltage	V_F	$I_F=150\text{mA}$	-	U.S.L*)x1.1
Reverse Current	I_R	$V_R = 10\text{V}$	-	U.S.L*)x2.0
Total radiant flux	e	$I_F=150\text{mA}$	L.S.L*)x0.7	-

Notes

1.U.S.L: Upper standard level

L.S.L: Lower standard level

2. The above reliability tests is based on the verification of a single/strip LED of Refond's existing experimental platform, the reliability experiment was taken under good heat dissipation conditions. when customers applies the LED to the series and parallel circuit, should take consideration of all the factors such as the current, voltage distribution, heat dissipation and others.

3.The technical information shown in the data sheets is limited to the typical characteristics and circuit examples of the referenced products. It does not constitute the warranting of industrial property nor the granting of any license.

3. SMT Reflow Soldering Instructions SMT 回流焊说明

3.1 SMT Reflow Soldering Instructions SMT

Fig.3-1 SMT Reflow Soldering Instructions

Table 3-1 SMT Reflow Soldering Instructions

Average temperature rise speed	T_{smax}	T_P	Max 3 °C/ s	3 °C/
Preheating: minimum temperature	(T_{smin})			150 °C

Notes

(1) Reflow soldering should not be done more than twice. If more than 24 hours between the two solderings, LED will be damaged.

(2) When soldering, do not put stress on the LEDs during heating.

3.1.1 Soldering Iron

(1) When do soldering by hand, keep the temperature of iron below less 300 less than 3 seconds

(2) Soldering by hand should be done only one time.

3.1.2 Repairing

Repairing should not be done after the LEDs have been soldered. When repairing is unavoidable, a double-head soldering iron should be used (as below figure). It should be confirmed in advance whether the characteristics of LEDs will or not be damaged by repairing.

LED

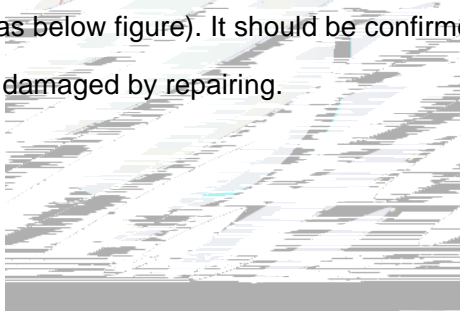

3.1.3 Cautions

(1) The encapsulated material of the LEDs is silicone. Therefore the LEDs have a soft surface on the top of package. The pressure to the top surface will be impacted on the reliability of the LEDs. Precautions should be taken to avoid the strong pressure on the encapsulated part. So when use the picking up nozzle, the pressure on the silicone resin should be proper. LED

(2) Components should not be mounted on warped (non coplanar) portion of PCB. After soldering, do not warp the circuit board. LED

(3) Do not apply mechanical force or excess vibration during the cooling process to normal temperature after soldering. Do not rapidly cool device after soldering.

4. Handling Precautions

4.1 Handling Precautions

(1) LED operating environment and sulfur element composition cannot be over 100PPM in the LED mating usage material. This is provided for informational purposes only and is not a warranty or endorsement. LED

(2) In order to prevent external material from getting into the inside of LED, which may cause the malfunction of LED, the single content of Bromine element is required to be less than 900PPM, the single content of Chlorine element is required to be less than 900PPM, the total content of Bromine element and Chlorine element in the external materials of the application products is required to be less than 1500PPM. This is provided for informational purposes only and is not a warranty or endorsement.

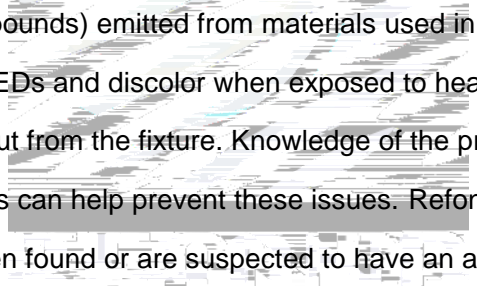

(3) VOCs (Volatile organic compounds) emitted from materials used in the construction of fixtures can penetrate silicone encapsulants of LEDs and discolor when exposed to heat and photonic energy. The result can be a significant loss of light output from the fixture. Knowledge of the properties of the materials selected to be used in the construction of fixtures can help prevent these issues. Refond advises against the use of any chemicals or materials that have been found or are suspected to have an adverse effect on device performance or reliability. To verify compatibility, Refond recommends that all chemicals and materials be tested in the specific application and environment for which they are intended to be used. Attaching LEDs, do not use adhesives that outgas organic vapor.

(4) Handle the component along the side surface by using forceps or appropriate tools; Do not directly touch or Handle the silicone lens surface, it may damage the internal circuitry.





Version History/

Date	Revisor	Version	Verifier	Remarks
2020-09-20		E0		

www.refonduvled.com



Declare

This specification is written both in English and in Chinese and the latter is formal.