

SPECIFICATION

产品规格书

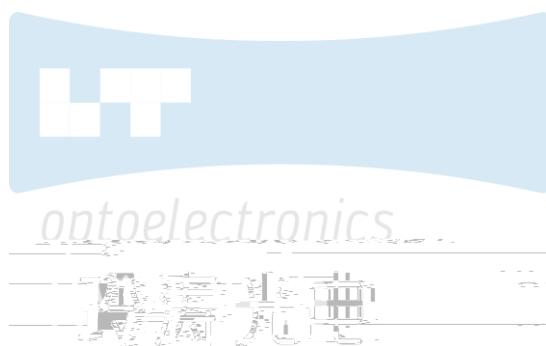

REFONDLT P/N 产品型号

RF-TVH*EC33MCN

R&D 研发

Mass Product 量产供货

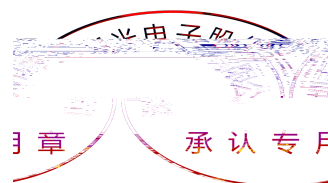

Contents/ 目录

1.Description 产品介绍.....	3
1.1 Description 描述.....	3
1.1.1 Features 特征.....	34
1.1.2 Applications 应用.....	3
1.2 Package Dimension 产品尺寸.....	4
1.3 Product Parameters产品参数.....	5
1.4 Bin Range Of Forward Voltage and Luminous Flux (IF=600mA)电压与流明分BIN范围(IF=600mA).....	19
1.5 Typical optical characteristics curves	

ontoelectronics

睿光电子

1. Description 产品介绍

1.1 Description 描述

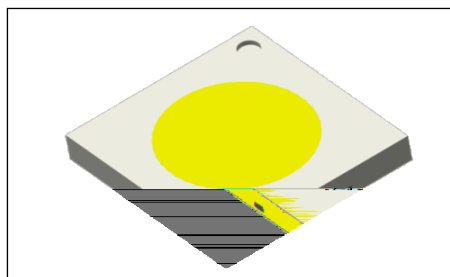

The White LED which was fabricated using a blue chip and the phosphor, outline size 3.0mm × 3.0mm × 0.6mm.

该产品为白光LED，是由蓝光芯片激发荧光粉而形成，尺寸为3.0mm × 3.0mm × 0.6mm。

1.1.1 Features 特征

EMC Package. EMC封装

Extremely wide viewing angle. 发光角度大

Suitable for all SMT assembly and solder process. 适用于所有的SMT组装和焊接工艺

Available on tape and reel. 适用于载带及卷轴

Moisture sensitivity level: Level 3. 防潮等级 Level 3

RoHS compliant. 满足RoHS要求

1.1.2 Applications 应用

Backlight for LCD, TV or monitor. LCD背光、电视或显示器

Switch and symbol. 转换器、开关和标志等

Optical indicator. 光学指示

Indoor display. 室内显示

Tubular light application. 用于日光灯管

General use. 其他应用

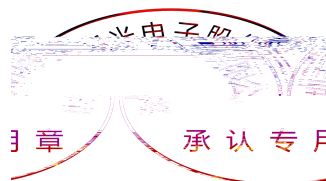

1.2 Package Dimension 产品尺寸

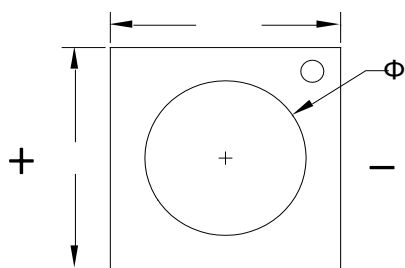

Fig.1-1 Top view 正面视图

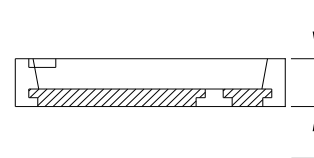

Fig.1-2 Side view 侧面视图

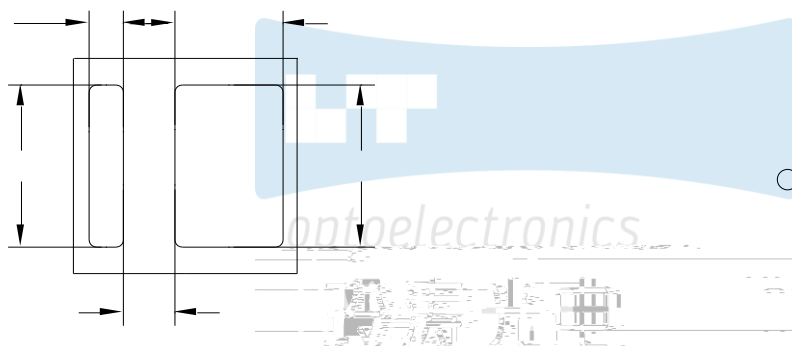

Fig.1-3 Bottom view 背面视图

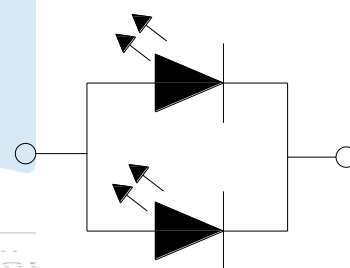

Fig.1-4 Polarity 极性

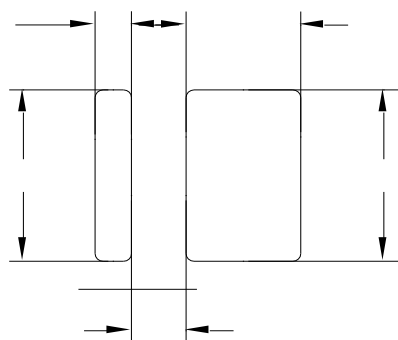
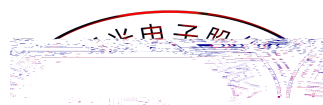

Fig.1-5 Soldering patterns 推荐焊盘

Notes 备注:

- (1) All dimensions units are millimeters. 所有尺寸标注单位为毫米
- (2) All dimensions tolerances are $\pm 0.2\text{mm}$ unless otherwise noted. 除特别标注外, 所有尺寸公差为 ± 0.2 毫米



印章 承认专用

1.3 Product Parameters 产品参数

Table 1-1 Electrical / Optical Characteristics at Ts=25°C 电性与光学特性

Item 项目	Symbol 符号	Test condition 测试条件	Value			Unit 单位
			Min. (最小值)	Typ (典型值)	Max. (最大值)	
Forward Voltage (正向电压)	V _F	I _F =600mA	2.8	---	3.6	V
Reverse Current (漏电流)	I _R	V _R =5V	---	---	10	uA
Luminous Flux (光通量)	Φ	I _F =600mA	115	---	180	Lm
Viewing Angle (发光角度)	2 1/2	I _F =600mA	---	120	---	deg
Thermal Resistance. (热阻)	R _{THJ-S}	I _F =600mA	---	12	---	°C/W

Table 1-2 Absolute Maximum Ratings at Ts=25°C 绝对最大值

Parameter (参数)	Symbol (符号)	Rating (值)	Units (单位)
Power Dissipation (功耗)	P _D	2160	mW
Forward Current (正向电流)	I _F	600	mA
Peak Forward Current (峰值电流)	I _{FP}	900	mA
Reverse Voltage (反向电压)	V _R	5	V
Electrostatic Discharge (HBM) (静电)	E _{SD}	2000	V
Operating Temperature (操作温度)	T _{OPR}	-10 ~ +80	°C
Storage Temperature and Humidity (储存温湿度)	T _{OPR}	Ta=5~30°C & RH≤60%	

Notes 备注:

- (1) 1/10 Duty cycle, 0.1ms pulse width. 脉宽0.1ms,占空比1/10.
- (2) The above forward voltage measurement allowance tolerance is $\pm 0.1V$. 以上所示电压测量误差 $\pm 0.1V$.
- (3) The above color coordinates measurement allowance tolerance is ± 0.005 . 以上所示坐标测量误差 ± 0.005 .
- (4) The above luminous intensity measurement allowance tolerance $\pm 5\%$. 上述发光强度的测试允许偏差为 $\pm 5\%$.
- (5) Care is to be taken that power dissipation does not exceed the absolute maximum rating of the product. 使用功率不能超过规定的最大值。
- (6) All measurements were made under the standardized environment of Refond. 所有测试都是基于瑞丰现有的标准测试平台。
- (7) When the LEDs are in operation the maximum current should be decided after measuring the package temperature junction temperature should not exceed the maximum rate. LED 使用的是士由流需带根据散热条件确定, 结温不能超过最大值。
- (8) ESD yield is over 90% at 2000V ESD (HBM). ESD protection during products handing is needed. 90%的LED通过人体模式ESD2000V 测试, 在操作时请注意静电防护。

1.4 Bin Range Of Forward Voltage and Luminous Flux (IF=600mA)电压与流明分 BIN 范围(IF=600mA)

Table 1-3 Bin Range Of Forward Voltage and Luminous Flux电压与流明分BIN范围(IF=600mA)

VF (V)	G1	G2	H1	H2	I1	I2	J1	J2
		2.8-2.9	2.9-3.0	3.0-3.1	3.1-3.2	3.2-3.3	3.3-3.4	3.4-3.5
Φ (lm)	T115	T120	T125	T130	T135	T140	T145	...
	115-120	120-125	125-130	130-135	135-140	140-145	145-150	...

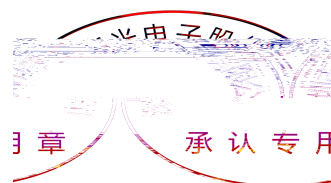

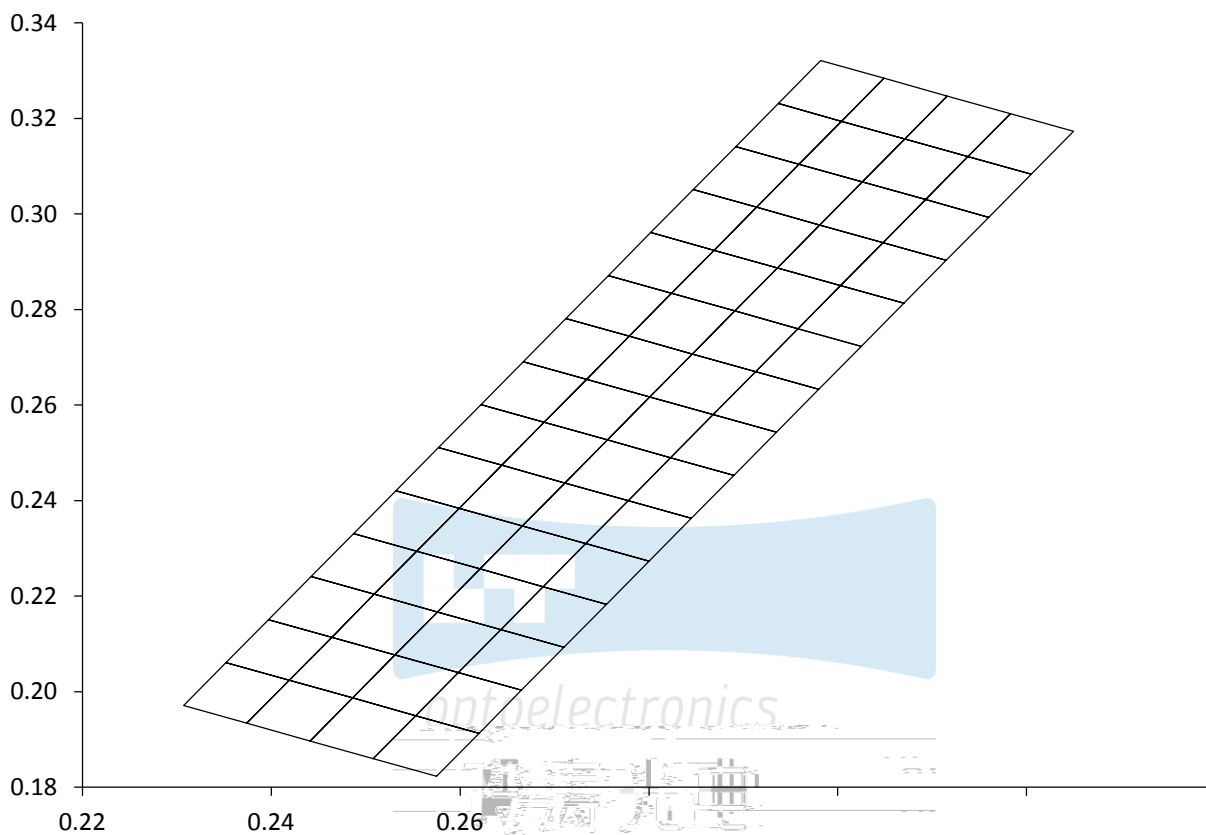
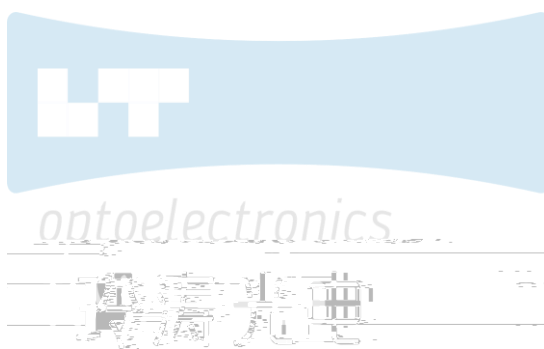

Fig 1-6 The C.I.E Chromaticity Diagram CIE色度图

Table 1-4 The C.I.E Chromaticity Diagram CIE色度图

BIN CODE	CIE-X1	CIE-Y1	CIE-X2	CIE-Y2	CIE-X3	CIE-Y3	CIE-X4	CIE-Y4
D00	0.3025	0.2723	0.2958	0.2760	0.3003	0.2850	0.3070	0.2813
D01	0.2980	0.2633	0.2913	0.2670	0.2958	0.2760	0.3025	0.2723
D02	0.2935	0.2543	0.2868	0.2580	0.2913	0.2670	0.2980	0.2633
D03	0.2890	0.2453	0.2823	0.2490	0.2868	0.2580	0.2935	0.2543
D04	0.2845	0.2363	0.2778	0.2400	0.2823	0.2490	0.2890	0.2453
D05	0.2800	0.2273	0.2733	0.2310	0.2778	0.2400	0.2845	0.2363
D06	0.2755	0.2183	0.2688	0.2220	0.2733	0.2310	0.2800	0.2273
D07	0.2710	0.2093	0.2643	0.2130	0.2688	0.2220	0.2755	0.2183
D08	0.2665	0.2003	0.2598	0.2040	0.2643	0.2130	0.2710	0.2093
D09	0.2620	0.1913	0.2553	0.1950	0.2598	0.2040	0.2665	0.2003
D10	0.2575	0.1823	0.2508	0.1860	0.2553	0.1950	0.2620	0.1913
D20	0.3070	0.2813	0.3003	0.2850	0.3048	0.2940	0.3115	0.2903
D21	0.3115	0.2903	0.3048	0.2940	0.3093	0.3030	0.3160	0.2993
D22	0.3160	0.2993	0.3093	0.3030	0.3138	0.3120	0.3205	0.3083
D23	0.3205	0.3083	0.3138	0.312	0.3183	0.321	0.325	0.3173

H00	0.2958	0.2760	0.2891	0.2797	0.2936	0.2887	0.3003	0.2850
H01	0.2913	0.2670	0.2846	0.2707	0.2891	0.2797	0.2958	0.2760
H02	0.2868	0.2580	0.2801	0.2617	0.2846	0.2707	0.2913	0.2670
H03	0.2823	0.2490	0.2756	0.2527	0.2801	0.2617	0.2868	0.2580
H04	0.2778	0.2400	0.2711	0.2437	0.2756	0.2527	0.2823	0.2490
H05	0.2733	0.2310	0.2666	0.2347	0.2711	0.2437	0.2778	0.2400
H06	0.2688	0.2220	0.2621	0.2257	0.2666	0.2347	0.2733	0.2310
H07	0.2643	0.2130	0.2576	0.2167	0.2621	0.2257	0.2688	0.2220
H08	0.2598	0.2040	0.2531	0.2077	0.2576	0.2167	0.2643	0.2130
H09	0.2553	0.1950	0.2486	0.1987	0.2531	0.2077	0.2598	0.2040
H10	0.2508	0.1860	0.2441	0.1897	0.2486	0.1987	0.2553	0.1950
H20	0.3003	0.2850	0.2936	0.2887	0.2981	0.2977	0.3048	0.2940
H21	0.3048	0.2940	0.2981	0.2977	0.3026	0.3067	0.3093	0.3030
H22	0.3071	0.3157	0.3026	0.3067	0.3093	0.3030	0.3138	0.3120
H23	0.3138	0.3120	0.3071	0.3157	0.3116	0.3247	0.3183	0.3210
K00	0.2891	0.2797	0.2824	0.2834	0.2869	0.2924	0.2936	0.2887
K01	0.2846	0.2707	0.2779	0.2744	0.2824	0.2834	0.2891	0.2797
K02	0.2801	0.2617	0.2734	0.2654	0.2779	0.2744	0.2846	0.2707
K03	0.2756	0.2527	0.2689	0.2564	0.2734	0.2654	0.2801	0.2617
K04	0.2711	0.2437	0.2644	0.2474	0.2689	0.2564	0.2756	0.2527
K05	0.2666	0.2347	0.2599	0.2384	0.2644	0.2474	0.2711	0.2437
K06	0.2621	0.2257	0.2554	0.2294	0.2599	0.2384	0.2666	0.2347
K07	0.2576	0.2167	0.2509	0.2204	0.2554	0.2294	0.2621	0.2257
K08	0.2531	0.2077	0.2464	0.2114	0.2509	0.2204	0.2576	0.2167
K09	0.2486	0.1987	0.2419	0.2024	0.2464	0.2114	0.2531	0.2077
K10	0.2441	0.1897	0.2374	0.1934	0.2419	0.2024	0.2486	0.1987
K20	0.2936	0.2887	0.2869	0.2924	0.2914	0.3014	0.2981	0.2977
K21	0.2981	0.2977	0.2914	0.3014	0.2959	0.3104	0.3026	0.3067
K22	0.3004	0.3194	0.2959	0.3104	0.3026	0.3067	0.3071	0.3157
K23	0.3071	0.3157	0.3004	0.3194	0.3049	0.3284	0.3116	0.3247
T00	0.2824	0.2834	0.2757	0.2871	0.2802	0.2961	0.2869	0.2924
T01	0.2779	0.2744	0.2712	0.2781	0.2757	0.2871	0.2824	0.2834
T02	0.2734	0.2654	0.2667	0.2691	0.2712	0.2781	0.2779	0.2744
T03	0.2689	0.2564	0.2622	0.2601	0.2667	0.2691	0.2734	0.2654
T04	0.2644	0.2474	0.2577					



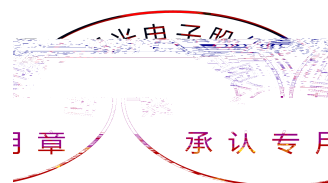

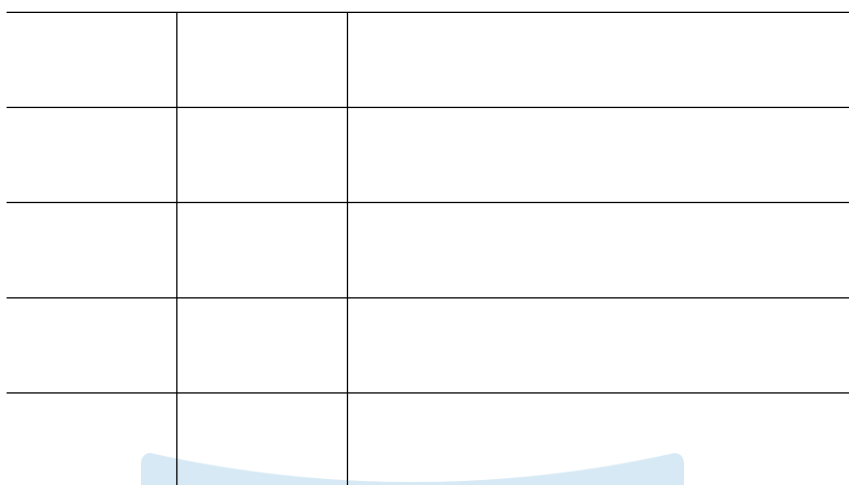

Fig 1-9 Solder Temperature Vs Relative Intensity 管脚温度与相对光强特性曲线

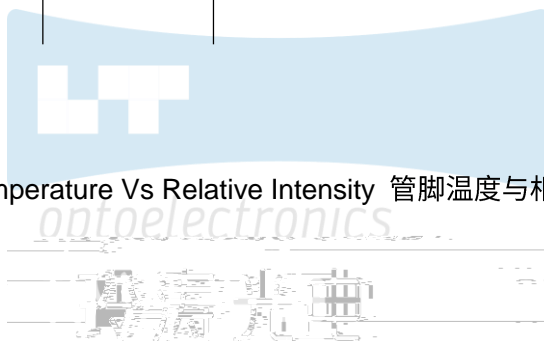
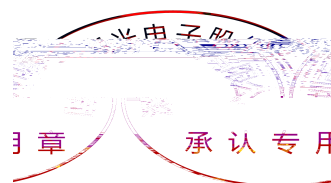
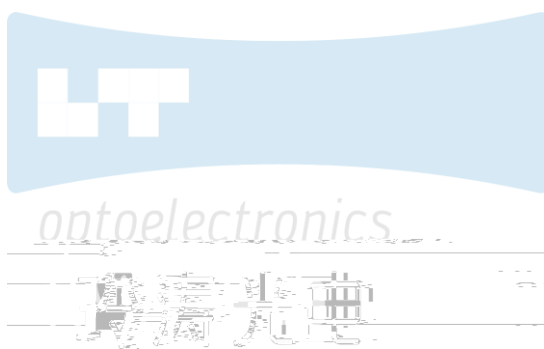

Fig 1-10 Solder Temperature Vs Forward Current 管脚温度与正向电流特性曲线



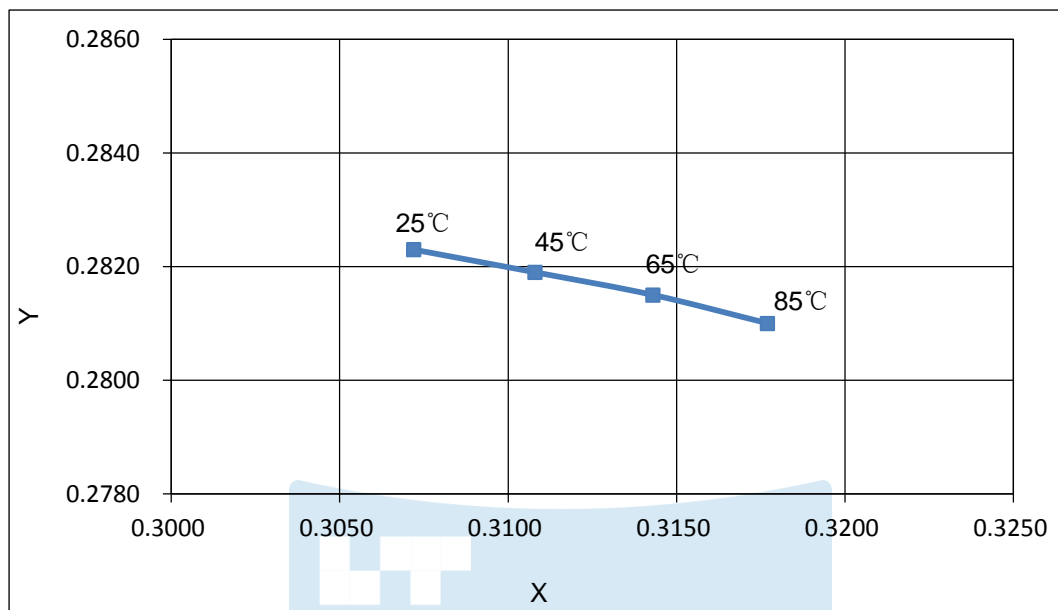
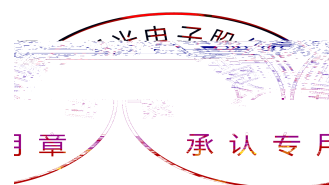
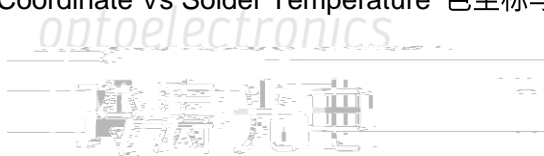

Fig 1-13 Chromaticity Coordinate Vs Solder Temperature 色坐标与管脚温度特性曲线



2. Packaging 产品包装

2.1 Packaging Specifications 包装规格

Package:5000pcs/reel.包装每卷5000pcs。

2.1.1 Carrier Tape Dimensions 载带尺寸



Fig 2-1 Carrier Tape Dimensions 载带尺寸

2.1.2 Reel Dimension 卷盘尺寸

Table 2-1 Reel Dimension 卷盘尺寸

A	16.9±0.1mm
B	178±1mm
C	59±1mm

Fig 2-2 Reel Dimension 卷盘尺寸

NOTES 备注:

The tolerances unless mentioned $\pm 0.1\text{mm}$. Unit : mm 注: 未注公差为 ± 0.1 毫米, 尺寸单位: 毫米

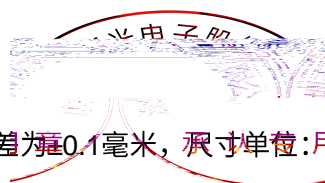

2.1.3 Label Form Specification 标签规格

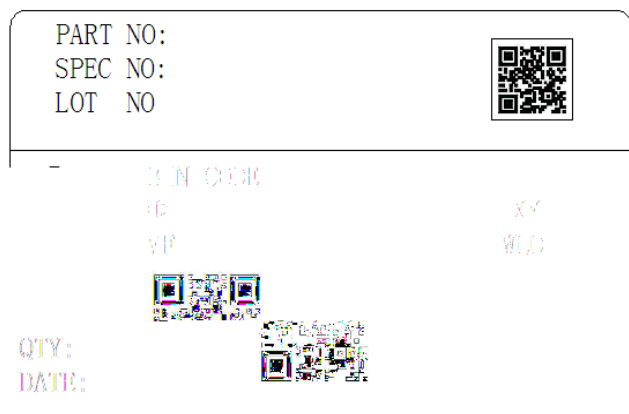

Fig 2-3 Label Form Specification 标签规格

Table 2-2 Label Form Specification 标签规格

PART NO.	Part Number	品名
SPEC NO.	Spec Number	规格
LOT NO.	Lot Number	批次号
BIN CODE	Bin Code	参数代码
Φ	Luminous flux	光通量
XY	Chromaticity Bin	色区
VF	Forward Voltage	正向电压
WLD	Wavelength	波长代码
QTY	Packing Quantity	数量
DATE	Made Date	生产日期

2.1.4 Moisture Resistant Packing Process 防潮包装过程

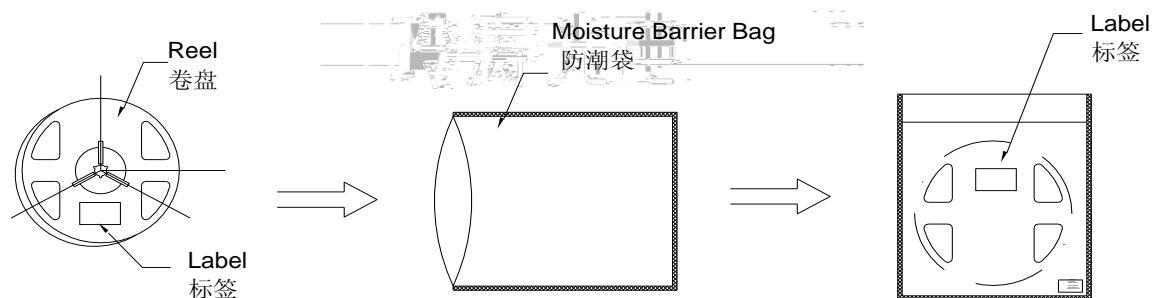

Fig 2-4 Moisture Resistant Packing Process 防潮包装过程

2.1.5 Cardboard Box 纸箱

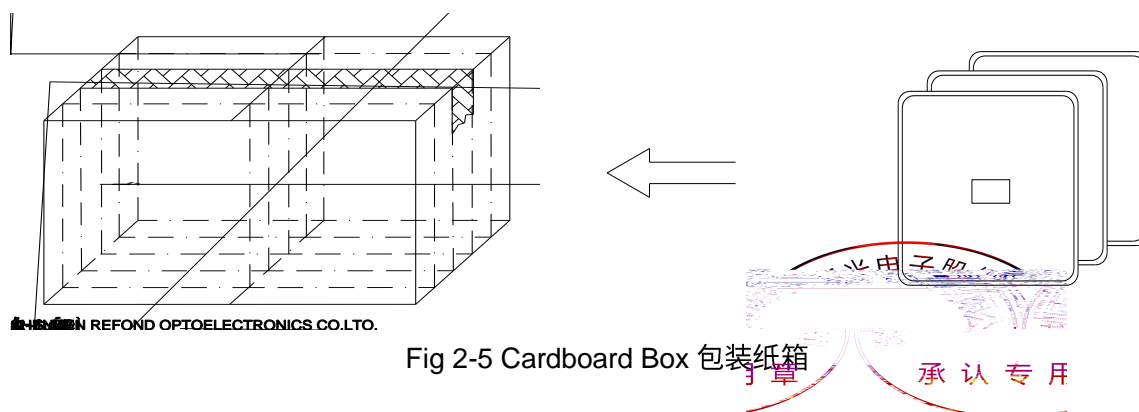
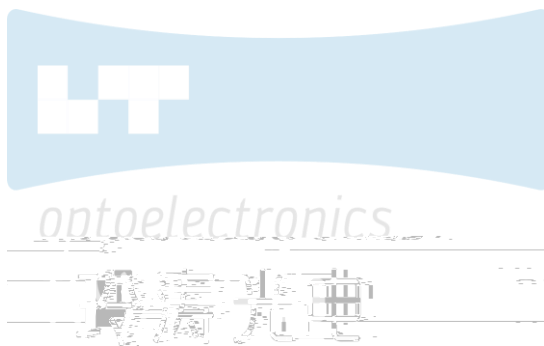

Fig 2-5 Cardboard Box 包装纸箱

2.1.6 Reliability Test Items And Conditions 信赖性测试项目及条件

Table 2-3 Reliability Test Items And Conditions 信赖性测试项目及条件

Test Items 项目	Ref.Standard 参考标准	Test Condition 测试条件	Time 时间	Quantity 数量	Ac/Re 接收/拒收
Reflow 回流焊	JESD22-B106	Temp:260°Cmax			



2.1.7 Criteria For Judging Damage 失效判定标准

Table 2-4 Criteria For Judging Damage 失效判定标准

Test Items 项目	Symbol 符号	Test Condition 测试条件	Criteria For Judgement 判定标准	
			Min. 最小	Max. 最大
Forward Voltage 正向电压	V_F	$I_F=600\text{mA}$	-	$U.S.L^*)\times 1.1$
Reverse Current 反向电流	I_R	$V_R = 5V$	-	$U.S.L^*)\times 2.0$
Luminous Flux 光通量	Φ	$I_F=600\text{mA}$	$L.S.L^*)\times 0.7$	-

NOTES 备注:

- (1) U.S.L: Upper standard level 规格上限 L.S.L: Lower standard level 规格下限
- (2) The above reliability tests is based on the verification of a single/strip LED of Refond's existing

3. SMT Reflow Soldering Instructions SMT回流焊说明

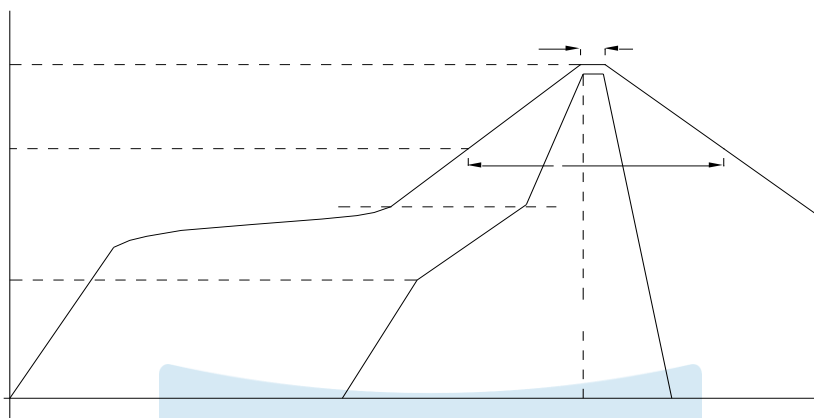
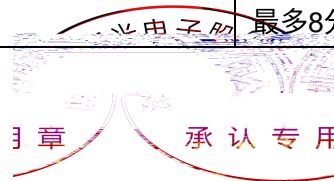

Fig 3-1 3. SMT Reflow Soldering Instructions SMT 回流焊说明

Table 3-1 SMT Reflow Soldering Instructions SMT 回流焊说明

Average temperature rise speed平均升温速度 (T _{max} 至T _P)	最高3 °C/秒 Max 3 °C/ s
Preheating: minimum temperature预热: 最低温度 (T _{min})	150 °C
Preheating: Max temperature预热: 最高温度 (T _{max})	200 °C
Preheating: Time预热: 时间 (T _{min} 至T _{max})	60 - 120秒 60s-120s
Time limited to maintain high temperature: the temperature限时维持高温: 温度 (T _L)	217 °C
Time limited to maintain high temperature: The Time 限时维持高温: 时间 (t _L)	最多60秒 Max 60s
Peak /Classification of temperature:峰值 / 分类温度 (T _P)	260 °C
Time limit classification of peak temperature time限时峰值分类温度: 时间 (t _p)	最多10秒 Max 10s
Hold time within 5 °C with the actual peak temperature (T _P) 与实际峰值温度 (T _P) 相差 5 °C 以内的保持时间	最多30秒 Max 30s
Cooling speed 降温速度	最高6 °C/秒 Max 6 °C/ s
Needed time from 25 °C to T _p 25 °C 升至峰值温度所需时间	最多8分钟 Max 8 minutes



NOTES 备注:

(1) Reflow soldering should not be done more than two times. In the case of more than 24 hours passed soldering after first, LEDs will be damaged. 回流焊次数不可以超过两次，两次回流焊的时间间隔如果超过24小时，LED可能由于吸湿而损坏。

(2) When soldering, do not put stress on the LEDs during heating. 焊接LED时不要再次加热LED的顶部表面。

3.1.1 Soldering Iron 烙铁焊接

(1) When hand soldering, keep the temperature of iron below less 300 less than 3 seconds

当手工焊接LED时，烙铁的温度应低于300°C，时间不可超过3秒。

(2) The hand solder should be done only one time. 手工焊接只可焊接一次。

3.1.2 Repairing 修复

Repair should not be done after the LEDs have been soldered. When repairing is unavoidable, a double-head soldering iron should be used (as below figure). It should be confirmed in advance whether the characteristics of LEDs will or will not be damaged by repairing. LED回流焊后不应该修复，当必须修复时，必须使用双头烙铁，而且事先应确认此种方式会不会损坏LED本身的特性。

3.1.3 Cautions 注意事项

(1) The encapsulated material of the LEDs is silicone. Therefore the LEDs have a soft surface on the top of package. The pressure to the top surface will be influence to the reliability of the LEDs. Precautions should be taken to avoid the strong pressure on the encapsulated part. So when use the picking up nozzle, the pressure on the silicone resin should be proper. LED封装胶为硅胶，表面较软，用力按压胶体表面会影响LED可靠性，因此应

(2)

4. Handling Precautions 使用注意事项

(1) LED operating environment and sulfur element composition cannot be over 100PPM in the LED mating usage material. This is provided for informational purposes only and is not a warranty or endorsement. LED 工作环境及与 LED 匹配的材料中硫元素及化合物成份不可超过 100PPM. 这只是一个建议，不作任何品质担保。

(2) In order to prevent external material from getting into the inside of LED, which may cause the malfunction of LED, the single content of Bromine element is required to be less than 900PPM, the single content of Chlorine element is required to be less than 900PPM, the total content of Bromine element and Chlorine element in the external materials of the application products is required to be less than 1500PPM. This is provided for informational purposes only and is not a warranty or endorsement. 为了防止外界物质进入 LED 内部以造成 LED 的损伤，所处环境及所用套件等等，单一的溴元素含量要求小于 900PPM，单一氯元素含量要求小于 900PPM，溴元素和氯元素总量必须小于 1500PPM. 这只是一个建议，不作任何品质担保。

(3) VOCs (Volatile organic compounds) emitted from materials used in the construction of fixtures can penetrate silicone encapsulants of LEDs and discolor when exposed to heat and photonic energy. The result can be a significant loss of light output from the fixture. Knowledge of the properties of the materials selected to be used in the construction of fixtures can help prevent these issues. Refond advises against the use of any chemicals or materials that have been found or are suspected to have an adverse affect on device performance or reliability. To verify compatibility, Refond recommends that all chemicals and materials be tested in the specific application and environment for which they are intended to be used. Attaching LEDs, do not use adhesives that outgas organic vapor. 应用套件中的挥发性物质会渗透到 LED 内部，在通电产生光子及热的条件下，会导致 LED 灯罩变色，进而造成严重光衰。提前了解套件材料能够避免产生这些问题。瑞丰反对使用任何可能对 LED 的性能或可靠性有害的物质或材料。无论这些材料是否已经验证过的还是经验证过的。针对特定的应用和使用环境，瑞丰建议对所有的物质和材料进行相容性的测试。在贴装 LED 时候，不要使用能产生有机挥发性气体的粘结剂。

(4) Handle the component along the side surface by using forceps or appropriate tools; do not directly touch or Handle the silicone lens surface, it may damage the internal circuitry. 通过侧面的边缘用手或工具来拿取 LED 元件，不要直接用手或尖锐金属压胶体表面，它可能会损坏内部电路。

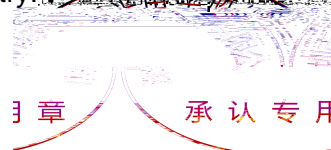

Fig 4-1

(5) In designing a circuit, the current through each LED can not be exceed the absolute maximum rating specified for each LED. In the meanwhile, resistors for protection should be applied, otherwise slight voltage shift



Table 4-1 Storage 储存

Conditions 种类		Temperature 温度	Humidity 湿度	Time 时间
Storage 储存	Before Opening Aluminum Bag 拆包前	≤30°C	≤75%	Within 1 Year From Date 一年内
	After Opening Aluminum Bag 拆包后	≤30°C	≤60%	24hours 24小时
Baking 烘烤		60±5°C	-	≥24hours 大于24小时

(8) If the moisture absorbent material silica gel has faded away or the LEDs have exceeded the storage time baking treatment should be performed after unpacking and based on the following condition 65 5 for above 24 hours.如果干燥剂或包装失效，或者产品不符合以上有效储存条件，需拆包后进行烘烤，烘烤条件：60 ±5°C，大于 24 小时。

If the package is flatulence or damaged, please notify the sales staff to assist.如果包装胀气或者破损，请通知销售人员协助处理。

(9) Similar to most Solid state devices; LEDs are sensitive to Electro-Static Discharge (ESD) and Electrical Over Stress (EOS). 像其他的半导体电子器件一样，LED 对静电过流击穿非常敏感，需要做好防护。

(10) Other points for attention, please refer to our relevant information.

其它注意事项请参照瑞丰相关资料。

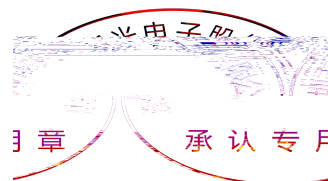

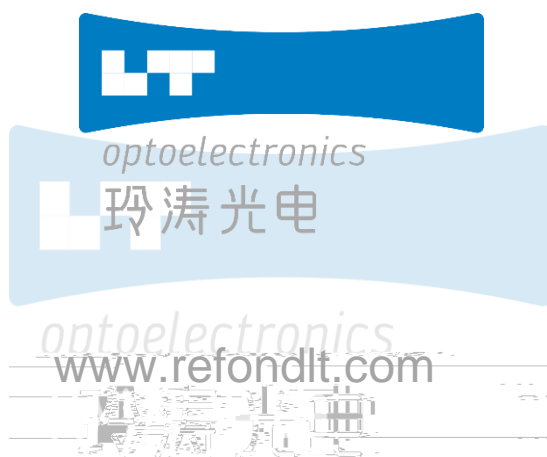

Declare 申明

This specification is written both in English and in Chinese and the latter is formal.

产品规格书以中英文方式书写，若有冲突以中文版本为准。

