

SPECIFICATION

LT P/N

LT3014WH-B-Q

R&D

Mass Product



1. E

1.1

1.2

1.3

1.4

1.5

1.6

(IF=

1.7

2. F

2.1

2.1

2.1

2.1

2.2

2.3

2.4

2.5

3. E

3.1

4. F

4.1

1. Description

1.1 General Description

The White LED, which was fabricated by using a blue chip and the phosphor.

Product Package: 3.0mmX1.4mmX0.7mm.

LED, : 3.0mmX1.4mmX0.7mm

1.2 Features

PLCC Package. PLCC

Wide viewing angle.

Suitable for all SMT assembly and solder process. SMT

Available on tape and reel.

Moisture sensitivity level: Level 3. Level 3

RoHS compliant. RoHS

1.3 Application

LCD Back Light. LCD

1.4 Package Dimension 7-up.

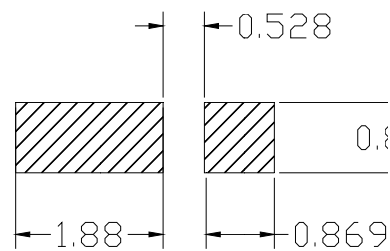
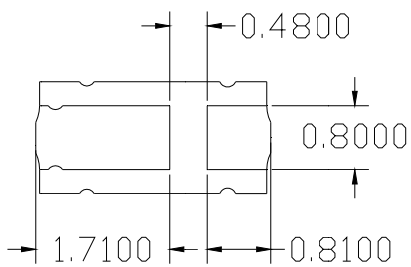
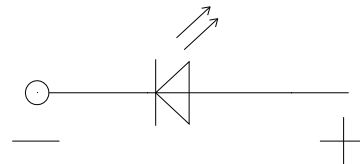
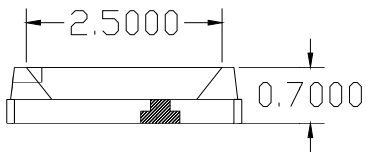
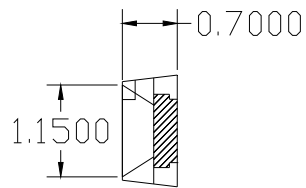
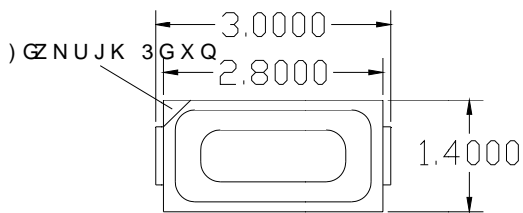

5 H F R Q G H R G L V L Q J S

Notes =# Æ

All dimensions units are millimeters v ? p . =# < f p"!2©

All dimensions tolerances are r0.1mm unless otherwise noted.Lš(a =# L , v ? p . ç \$

1.5 Product Parameters

Table 1-1 Electrical / Optical Characteristics at Ts=25°C

Item	Symbol	Test Condition	Value			Unit
			Min.	Typ.	Max.	
Forward Voltage	V_F	$I_F=30\text{mA}$	---	3.1	---	V
Reverse Current	I_R	$V_R=5\text{V}$	---	---	1	μA
Luminous Intensity	I_v	$I_F=30\text{mA}$	---	4000	---	mcd
Viewing Angle	2 1/2	$I_F=30\text{mA}$	---	120	---	deg

Table 1-2 Absolute Maximum Ratings at Ts=25°C

Parameter	Symbol	Rating	Units
Forward Current	I_F	35	mA
Peak Forward Current	I_{FP}	100	mA
Reverse Voltage	V_R	5	V
Electrostatic Discharge (HBM)	E_{SD}	2000	V
LED Junction Temperature (LED)	T_j	105	
Operating Temperature	T_{OPR}	-30 ~ + 85	
Storage Temperature	T_{STG}	-40~+100	

Notes

1. 1/10 Duty cycle, 0.1ms pulse width. 0.1ms,
2. The above forward voltage measurement allow:
3. The above color coordinates measurement allo
4. The above luminous intensity measurement allk
5. Care is to be taken that power dissipation does

6. All measurements were made under the standa

7. When the LEDs are in operation the maximum c
 temperature, junction temperature should not ex

1.6 Bin Range Of Forward BIN (IF=30mA)

Table 1-3 Bin Rang

BIN CODE	Min(mcd)
	P50
P51	4050
P52	4250
P53	4450
P54	4650
P55	4850

Noti

V
IV

Table 1-6 Bin Range of Chromaticity Coordinates Block (I F=30mA ; Ta=25)

J13	0.2526	0.2260	J14	0.2612	0.2418	J15	0.2698	0.2576
	0.2612	0.2418		0.2698	0.2576		0.2784	0.2734
	0.2664	0.2418		0.2750	0.2576		0.2836	0.2734
	0.2578	0.2260		0.2664	0.2418		0.2750	0.2576
J16	0.2784	0.2734	K13	0.2578	0.2260	K14	0.2664	0.2418
	0.2870	0.2892		0.2664	0.2418		0.2750	0.2576
	0.2922	0.2892		0.2716	0.2418		0.2802	0.2576
	0.2836	0.2734		0.2630	0.2260		0.2716	0.2418
K15	0.2750	0.2576	K16	0.2836	0.2734	M13	0.2630	0.2260
	0.2836	0.2734		0.2922	0.2892		0.2716	0.2418
	0.2888	0.2734		0.2974	0.2892		0.2768	0.2418
	0.2802	0.2576		0.2888	0.2734		0.2682	0.2260
M14	0.2716	0.2418	M15	0.2802	0.2576	M16	0.2888	0.2734
	0.2802	0.2576		0.2888	0.2734		0.2974	0.2892
	0.2854	0.2576		0.2940	0.2734		0.3026	0.2892
	0.2768	0.2418		0.2854	0.2576		0.2940	0.2734

Notes

1 Measurement uncertainty of the color coordinates:± 0.003.

± 0.003.

2 The new white dustbin refers to the application of small backlight standard.

1.7 Typical Optical Characteristics Curves

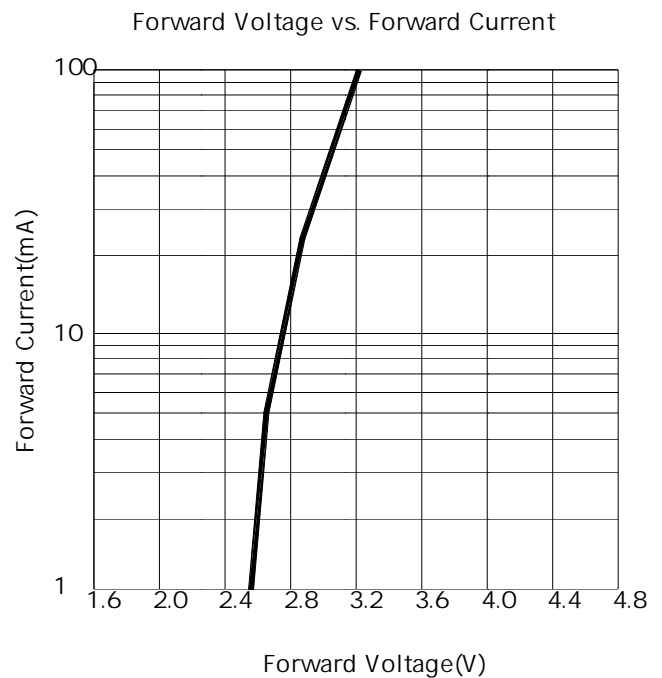
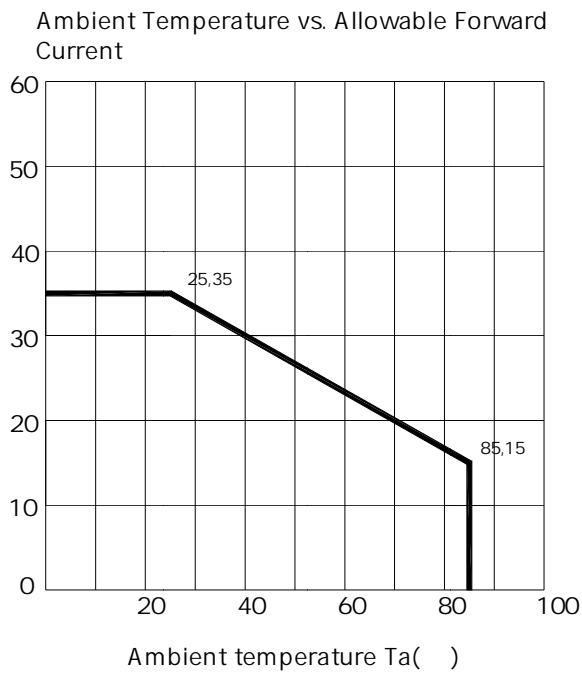
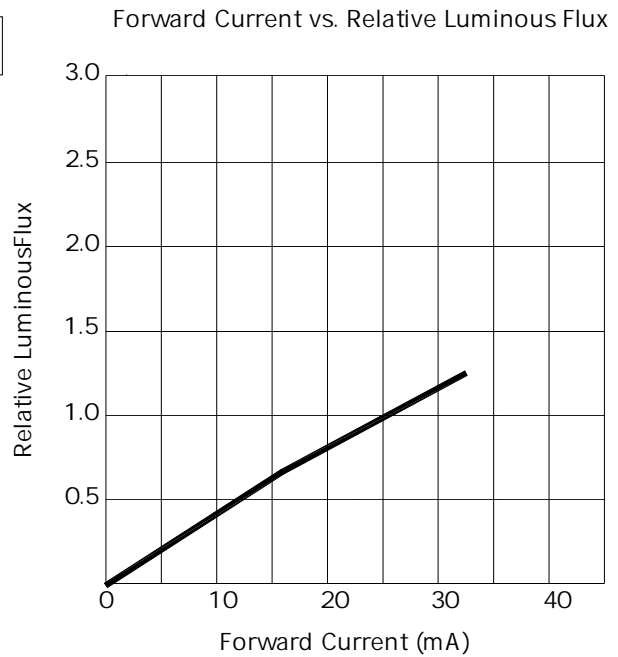
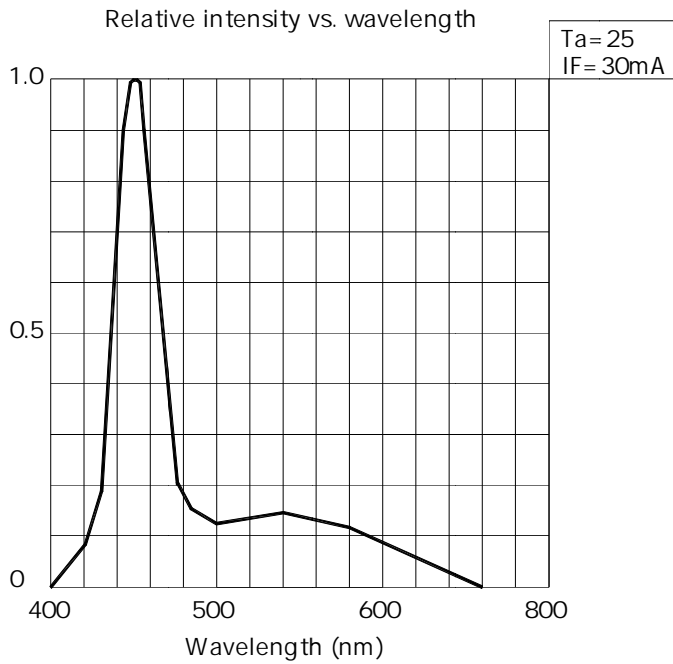

Ambient Temperature vs. Forward Voltage

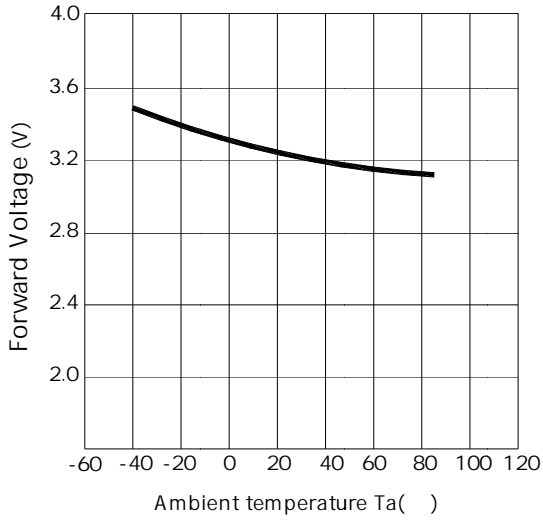

Ambient Temperature vs. Relative Luminous Flux

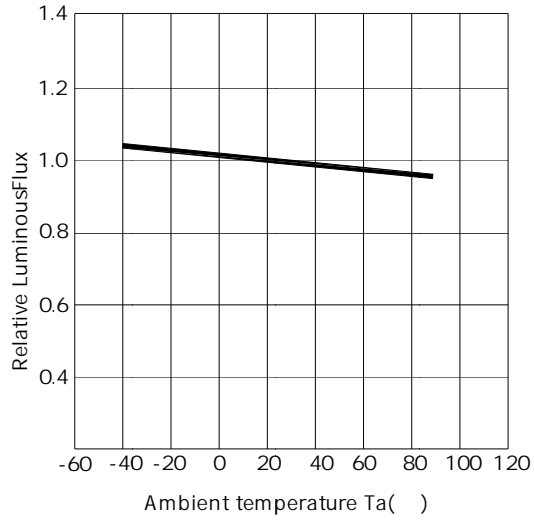

Duty Ratio vs. Allowable Forward Current

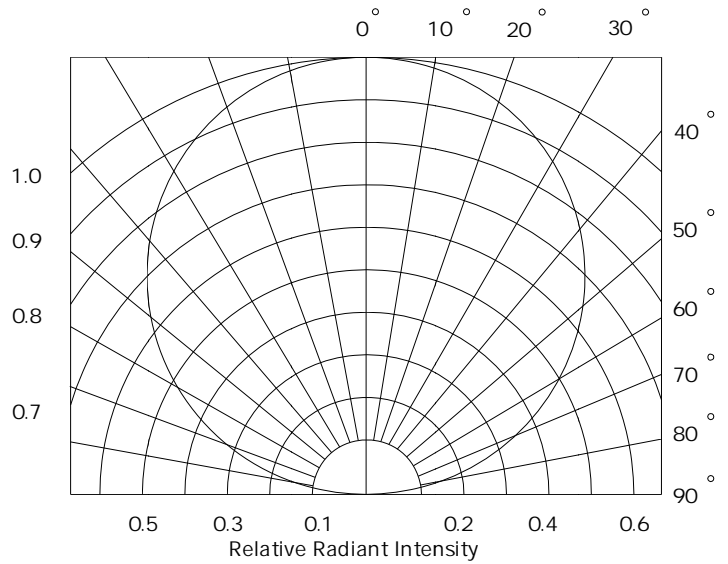
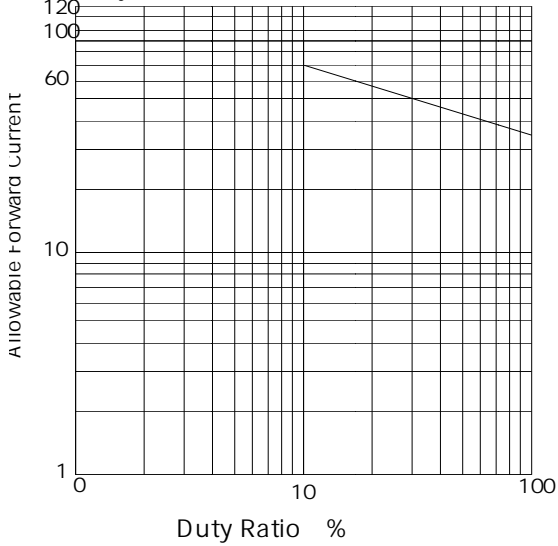

Packaging Specification

Package: 4000pcs/reel

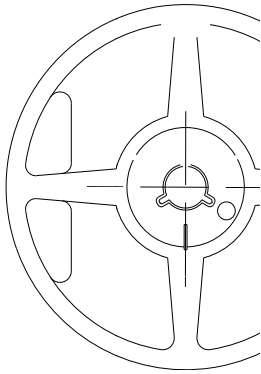

2.1.1 Carrier Tape Dimension

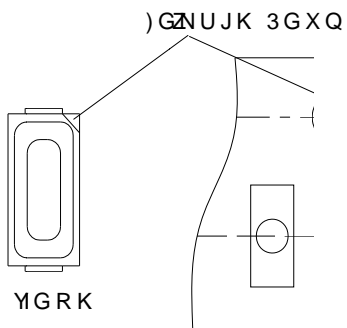

Notes: # Æ

The tolerances unless mer

2.1.2 Label Form Specification

Table 2-2 Label Map



Table 2-3 Label Form Specification

PART NO.	Part Number
BIN CODE	Bin Code
IV	Luminous intensity
V_F	Forward Voltage
WL	Wavelength
QTY	Packing Quantity
DATE	Made Date
LOT NO	Lot Number

2.2 Moisture Resistant Packing

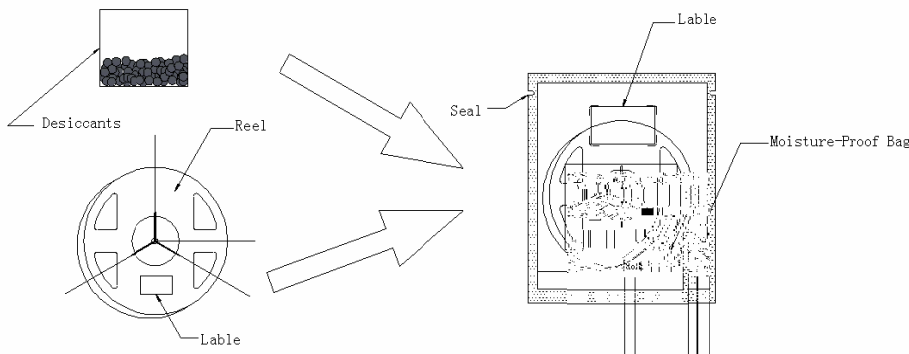

Fig.2-4 Moisture Resistant Packing

2.3 Cardboard Box

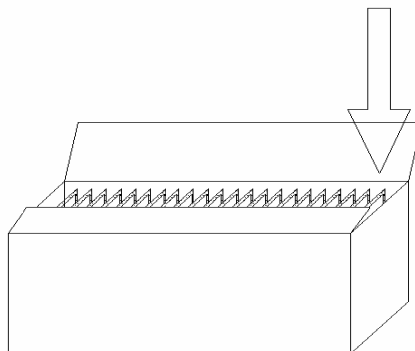

Fig.2-5 Cardboard Box

2.4 Reliability Test Items And Condi

Table 2-6 Reliability Test It

Test Items	Test Con
Reflow	Temp:260 T=10 s
Thermal Shock	-40 20min 100 20
High Temperature Storage	Temp:1
Low Temperature Storage	Temp:-4
Life Test	Ta=2rj84 308.780T Or0.1G0.1J10.j ET w.26M [10.d89.94 5.f6 223.26 6503
High Temperature and Humidity storage	
Temperature Humidity Operation Life	

2.5 Criteria For Judging Da

Table 2-

Test Items	Syn
Forward Voltage	V
Reverse Current	I
Luminous Flux	

Notes

- 1.U.S.L: Upper standard level L.S.L: Lower standard level
- 2.The above reliability tests is based on the verification of a single/strip LED of LT existing experimental platform,the reliability experiment was taken under good heat dissipation conditions. when customers applies the LED to the series and parallel circuit, should take consideration of all the factors such as the current, voltage distribution, heat dissipation and others. / LED
- LED

3.The technical information shown in the data sheets is limited to the typical characteristics and circuit examples of the referenced products. It does not constitute the warranting of industrial property nor the granting of any license.

3. SMT Reflow Soldering Instructions SMT

3.1 SMT Reflow Soldering Instructions

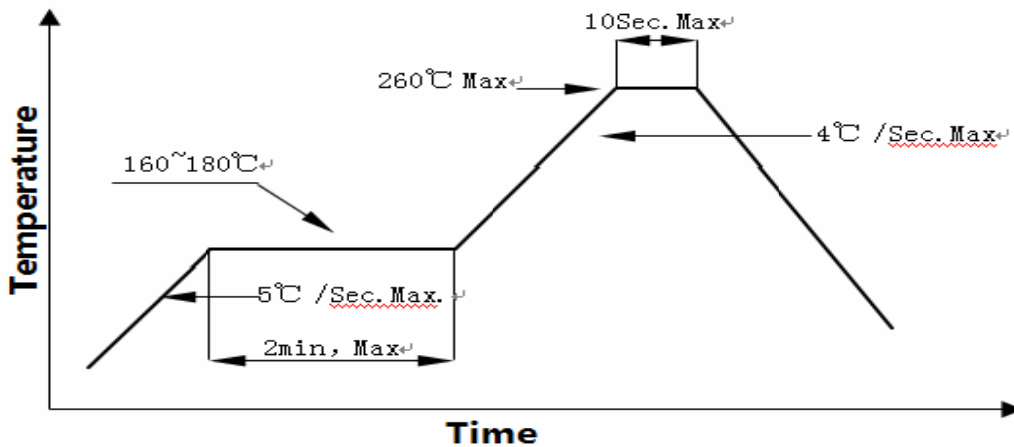

Fig.3-1 SMT Reflow Soldering Map

Fig.3-2 SMT Reflow Soldering Instructions SMT

Average temperature rise speed	T_{smax} T_P	5 °C/	Max 5 °C/ s
Preheating: minimum temperature	(T_{smin})	160 °C	
Preheating: Max temperature	(T_{smax})	260 °C	
Preheating: Time	T_{smin} T_{smax}	60 - 120	60s-120s
Time limited to maintain high temperature: the temperature	(T_L)	217 °C	
Time limited to maintain high temperature: The Time	(t_L)	60	Max 60s
Peak /Classification of temperature:	/ (T_P)	260 °C	
Time limit classification of peak temperature time	t_p	10	Max 10s
(T_P) 5 °C	Hold time within 5 °C with the actual peak temperature (TP)	30	Max 30s
Cooling speed		6 °C/	Max 6 °C
25 °C	Needed time from 25 °C to T_p	8	Max 8 minu

Notes

(1)Reflow soldering should not be done more than twice. If more than 24 hours between the two solderings , LED will be darr

24 LED

(2)Whensoldering , do not put stress on the LEDs during heating.

3.1.1 Soldering Iron

(1) When do soldering by hand, keep the temperature of iron below less 300 less than 3 seconds.

300 3

(2) Soldering by hand should be done only one time.

3.1.2 Repairing

Repairing should not be done after the LEDs have been soldered. When repairing is unavoidable, a double-head soldering iron should be used (as below figure). It should be confirmed in advance whether the characteristics of LEDs will or not be damaged by repairing.

LED #w'@ D C ÉB \$ C . %o ûN± \$ C, , ûN± µ+^ j' J÷ ,6B J Á ~ Ê.µAÚ!š 0 ĩ E P C P • ...LED bDá°(] >

3.1.3 Cautions # E ÁN⁻

(1) The encapsulated material of the LEDs is silicone. Therefore the LEDs have a soft surface on the top of package. The pressure to the top surface will be impacted on the reliability of the LEDs. Precautions should be taken to avoid the strong pressure on the encapsulated part. So when use the picking up nozzle, the pressure on the silicone resin should be proper. LED 7>û7, p.{ 7, ,>žM⁻

E¹Ež, +^ Ñ ? Á 7, %o>žM⁻ P § LED %M-], lš Ê ?N° Lh à óFµ f ^ ? Á ž, , %o µ+^ n j, , 7, %o>žM⁻, ° Á Ñ Ê e ! %o, ° >

(2) Components should not be mounted on warped (non coplanar) portion of PCB. After soldering, do not warp the circuit board. LED &¥* C?.'@ Û ^ e (, ° PCB µ @ , '@ Û • D , • C? . e Í4õ D%µ >

(3) Do not apply mechanical force or excess vibration during the cooling process to normal temperature after soldering. Do not rapidly cool device after soldering. #w'@ • D í aEý0A c , C? . / † Ī Ō Ö L Ñ , • C? . ?M= P , #w'@ D , C? . Gý+^%ö • í a , ° ĩ E >

4. Handling Pre caution s Ý ÷ µ+^# E ÁN⁻

4.1 Handli ng Preca utions Ý ÷ µ+^# E ÁN⁻

(1) LED operating environment and sulfur element composition cannot be over 100PPM in the LED mating usage material. This is provided for informational purposes only and is not a warranty or endorsement. LED ')á ' D LED F8Gf, ° † Ī c. j y3V L > (Ý F 3 C %C » Eý100PPM. F e 6 ` 0Aä , C ' 1 < ÷ C^ û >

(2) In order to prevent external material from getting into the inside of LED, which may cause the malfunction of LED, the single content of Bromine element is required to be less than 900PPM, the single content of Chlorine element is required to be less than 900PPM, the total content of Bromine element and Chlorine element in the external materials of the application products is required to be less than 1500PPM. This is provided for informational purposes only and is not a warranty or endorsement. p ¼Lh ĩ L +, (ÝC^F) LED »G FV F LED , ° Z , v :)á ' v+^ • , 1 • 1 • , < 6, ° \$ê y3V aH ? . "x E Ä 900PPM , < 6" e y3V aH ? . "x E Ä 900PPM , \$ê y3V D " e y3V q aH û N±E Ä 1500PPM. F e 6 ` 0Aä , C ' 1 < ÷ C^ û >

(3) VOCs (Volatile organic compounds) emitted from materials used in the construction of fixtures can penetrate silicone encapsulants of LEDs and discolor when exposed to heat and photonic energy. The result can be a significant loss of light output from the fixture. Knowledge of the properties of the materials selected to be used in the construction of fixtures can help prevent

these issues. LT advises against the use of a
affect on device performance or reliability. To
specific application and environment for which
organic vapor.

(4) Handle the component along the side surface
lens surface, it may damage the internal circuit.

(5) In designing a circuit, the current through
meanwhile, resistors for protection should be
happen. The driving circuit must be designed
to LED, migration can be generated resulting

(6) Thermal Design is of paramount importance
brightness decreased, color change and so on
design. LED

(7) Compared to standard encasement,
special care during processing.
solution must be applied to the
case other solvents are used, it
not recommended. Ultrasonic cleaning

Table 4-1 Storage

Conditions		Temperature	Humidity	Time
Storage	Before Opening Aluminum Bag	30	75%	Within 1 Year From Date
	After Opening Aluminum Bag	30	60%	24hours 24
Baking		60±5	-	24hours
				24

(8) If the moisture absorbent material silica gel has faded away or the LEDs have exceeded the storage time baking treatment should be performed after unpacking and based on the following condition 65±5 for above 24 hours.

60±5 24

If the package is flatulence or damaged, please notify the sales staff to assist.

(9) Similar to most Solid state devices; LEDs are sensitive to Electro-Static Discharge (ESD) and Electrical Over Stress (EOS).

LED

