

# SPECIFICATION

LT P/N

LT2604WH-A-Q

R&D

Mass Product



## Contents

|   |     |
|---|-----|
| 1. Description  | 3   |
| 1.1 General Description   | 3   |
| 1.2 Features  | 3   |
| 1.3 Application   | 3   |
| 1.4 Package Dimension   | 4   |
| 1.5 Product Parameters  | 4   |
| 1.6 Bin Range Of Forward Voltage and Luminous Intensity (IF=20mA) | BIN |
| (IF=20mA)   | 6   |
| 1.7 Typical Optical Characteristics Curves                        | 6   |
| 2. Packaging  | 13  |
| 2.1 Packaging Specification                                       | 13  |
| 2.1.1 Carrier Tape Dimension                                      | 13  |
| 2.1.2 Reel Dimension  | 12  |
| 2.1.3 Label Form Specification                                    | 14  |
| 2.2 Moisture Resistant Packing                                    | 14  |
| 2.3 Cardboard Box   | 14  |
| 2.4 Reliability Test Items And Conditions                         | 14  |
| 2.5 Criteria For Judging Damage                                   | 15  |
| 3. SMT Reflow Soldering Instructions SMT                          | 16  |
| 3.1 SMT Reflow Soldering Instructions SMT                         | 16  |
| 4. Handling Precautions   | 18  |
| 4.1 Handling Precautions  | 18  |

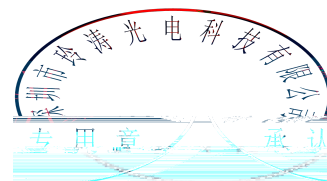

## 1. Description

### 1.1



The White LED, which was fabricated by using a blue chip and the phosphor.

Product Package: 2.6mmX0.7mmX0.4mm.

LED,

: 2.6mmX0.7mmX0.4mm

### 1.2 Features

PLCC Package. PLCC

Wide viewing angle.

Suitable for all SMT assembly and solder process.

SMT

Available on tape and reel.

Moisture sensitivity level: Level 3.

Level 3

RoHS compliant. RoHS

### 1.3 Application

LCD Back Light. LCD

Mobile Phones.

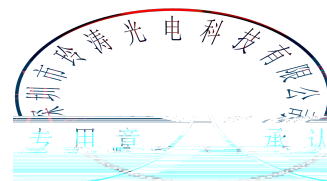



Table 1-2 Absolute Maximum Ratings at Ts=25°C

| Parameter            | Symbol | Rating | Units |
|----------------------|--------|--------|-------|
| Forward Current      | $I_F$  | 30     | mA    |
| Peak Forward Current | $I$    |        |       |

Notes

- 1/10 Duty cycle, 0.1ms pulse width.      0.1ms,      1/10.
- The above forward voltage measurement allowance tolerance is  $\pm 0.03V$ .       $\pm 0.03V$ .
- The above color coordinates measurement allowance tolerance is  $\pm 0.003$ .       $\pm 0.003$ .
- The above luminous intensity measurement allowance tolerance  $\pm 3\%$ .       $\pm 3\%$ .
- Care is to be taken that power dissipation does not exceed the absolute maximum rating of the product.
- All measurements were made under the standardized environment of LT.
- When the LEDs are in operation the maximum current should be decided after measuring the package temperature, junction temperature should not exceed the maximum rate. LED

## 1.6 Bin Range Of Forward Voltage and Luminous Intensity (IF=20mA)

### BIN (IF=20mA)

Table 1-3 Bin Range Of Luminous Intensity Bin (IF=20mA)

| BIN CODE | IF=20mA Test |           |          |          |
|----------|--------------|-----------|----------|----------|
|          |              | Max (mcd) | Min (lm) | Max (lm) |
| 30       | 2150         | 2250      | 6.00     | 6.25     |
| 31       | 2250         | 2350      | 6.25     | 6.50     |
| 32       | 2350         | 2450      | 6.50     | 6.75     |
| 33       | 2450         | 2550      | 6.75     | 7.00     |
| 34       | 2550         | 2650      | 7.00     | 7.25     |
| 35       | 2650         | 2750      | 7.25     | 7.50     |
| 36       | 2750         | 2850      | 7.50     | 7.75     |
| 37       | 2850         | 2950      | 7.75     | 8.00     |
| 38       | 2950         | 3050      | 8.00     | 8.25     |
| 39       | 3050         | 3150      | 8.25     | 8.50     |
| 40       | 3150         | 3250      | 8.50     | 8.75     |
| 41       | 3250         | 3350      | 8.75     | 9.00     |
| 42       | 3350         | 3450      | 9.00     | 9.25     |
| 43       | 3450         | 3550      | 9.25     | 9.5      |
| 44       | 3550         | 3650      | 9.5      | 9.75     |
| 45       | 3650         | 3750      | 9.75     | 10.0     |

Table 1-4 Bin Range Of Forward Voltage Bin

| BIN CODE | Min. | Max. | Unit | Condition |
|----------|------|------|------|-----------|
| V0       | 2.7  | 2.8  | V    | IF=20mA   |
| V1       | 2.8  | 2.9  |      |           |
| V2       | 2.9  | 3.0  |      |           |
| V3       | 3.0  | 3.1  |      |           |
| V4       | 3.1  | 3.2  |      |           |
| V5       | 3.2  | 3.3  |      |           |

#### Notes

VF Tolerance:  $\pm 0.03V$ @ IF= 20mA @ Ta=25

IV Tolerance:  $\pm 3\%$ @ IF= 20mA @ Ta=25

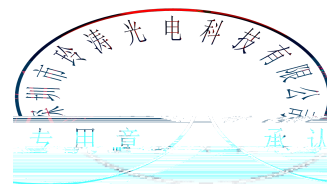
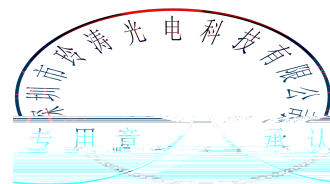

Fig. 1-5 The C.I.E. 1931 Chromaticity Diagram: ( L&T&H )

Table 1-6 Bin Range of Chromaticity Coordinates Block (IF=20mA ; Ta=25 )

|    |        |        |    |        |        |    |        |        |
|----|--------|--------|----|--------|--------|----|--------|--------|
| L0 | 0.2341 | 0.2016 | T0 | 0.2489 | 0.2072 | H1 | 0.2638 | 0.2192 |
|    | 0.2388 | 0.2113 |    | 0.2532 | 0.2151 |    | 0.2681 | 0.2272 |
|    | 0.2443 | 0.2083 |    |        |        |    |        |        |



|     |        |        |     |        |        |     |        |        |
|-----|--------|--------|-----|--------|--------|-----|--------|--------|
| L5  | 0.2576 | 0.2501 | T5  | 0.2704 | 0.2471 | H6  | 0.2853 | 0.2591 |
|     | 0.2623 | 0.2598 |     | 0.2747 | 0.2551 |     | 0.2896 | 0.2670 |
|     | 0.2678 | 0.2568 |     | 0.2798 | 0.2521 |     | 0.2947 | 0.2640 |
|     | 0.2631 | 0.2471 |     | 0.2755 | 0.2441 |     | 0.2904 | 0.2561 |
| L6  | 0.2623 | 0.2598 | T6  | 0.2747 | 0.2551 | H7  | 0.2896 | 0.2670 |
|     | 0.2670 | 0.2695 |     | 0.2790 | 0.2630 |     | 0.2939 | 0.2750 |
|     | 0.2725 | 0.2665 |     | 0.2841 | 0.2600 |     | 0.2990 | 0.2720 |
|     | 0.2678 | 0.2568 |     | 0.2798 | 0.2521 |     | 0.2947 | 0.2640 |
| L7  | 0.2670 | 0.2695 | T7  | 0.2790 | 0.2630 | H8  | 0.2939 | 0.2750 |
|     | 0.2717 | 0.2792 |     | 0.2833 | 0.2710 |     | 0.2982 | 0.2829 |
|     | 0.2772 | 0.2762 |     | 0.2884 | 0.2680 |     | 0.3033 | 0.2799 |
|     | 0.2725 | 0.2665 |     | 0.2841 | 0.2600 |     | 0.2990 | 0.2720 |
| L8  | 0.2717 | 0.2792 | T8  | 0.2833 | 0.2710 | H9  | 0.2982 | 0.2829 |
|     | 0.2764 | 0.2889 |     | 0.2876 | 0.2789 |     | 0.3025 | 0.2908 |
|     | 0.2819 | 0.2859 |     | 0.2927 | 0.2759 |     | 0.3076 | 0.2878 |
|     | 0.2772 | 0.2762 |     | 0.2884 | 0.2680 |     | 0.3033 | 0.2799 |
| L9  | 0.2764 | 0.2889 | T9  | 0.2876 | 0.2789 | H10 | 0.3025 | 0.2908 |
|     | 0.2811 | 0.2986 |     | 0.2919 | 0.2868 |     | 0.3068 | 0.2987 |
|     | 0.2866 | 0.2956 |     | 0.2970 | 0.2838 |     | 0.3119 | 0.2957 |
|     | 0.2819 | 0.2859 |     | 0.2927 | 0.2759 |     | 0.3076 | 0.2878 |
| L10 | 0.2811 | 0.2986 | T10 | 0.2919 | 0.2868 |     |        |        |
|     | 0.2858 | 0.3083 |     | 0.2962 | 0.2947 |     |        |        |
|     | 0.2913 | 0.3053 |     | 0.3013 | 0.2917 |     |        |        |
|     | 0.2866 | 0.2956 |     | 0.2970 | 0.2838 |     |        |        |

Fig. 1-7 The C.I.E. 1931 Chromaticity Diagram: ( LA&LB )

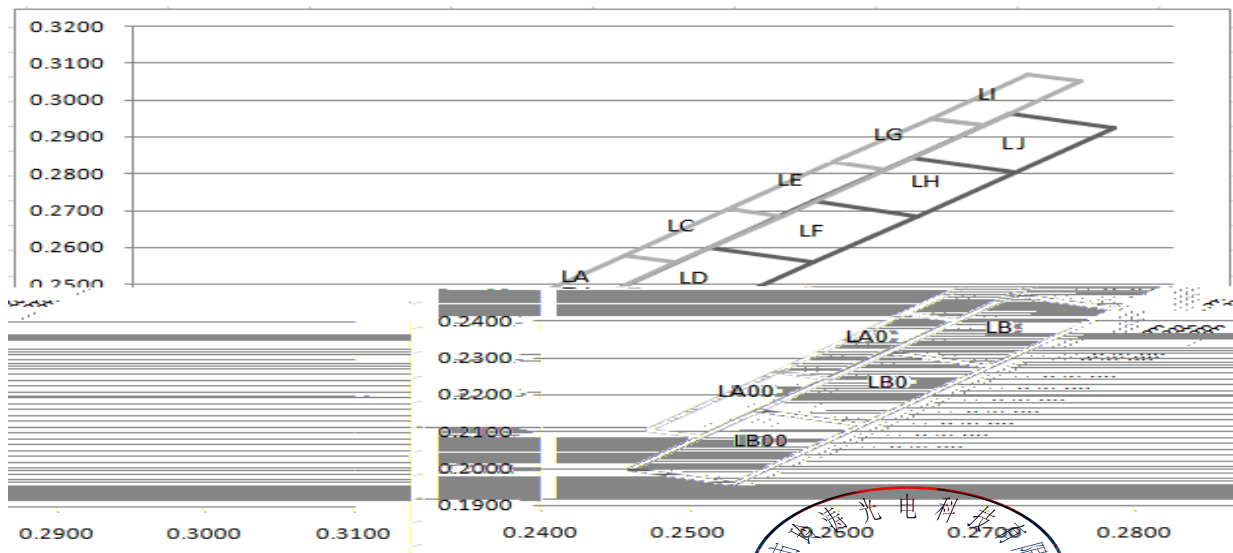

Table 1-8 Bin Range of Chromaticity Coordinates Block (IF=20mA ; Ta=25℃)



|      |        |        |     |        |        |    |        |        |
|------|--------|--------|-----|--------|--------|----|--------|--------|
| LA00 | 0.2472 | 0.2105 | LA0 | 0.2558 | 0.2263 | LA | 0.2644 | 0.2421 |
|      | 0.2558 | 0.2263 |     | 0.2644 | 0.2421 |    | 0.2730 | 0.2579 |
|      | 0.2593 | 0.2243 |     | 0.2679 | 0.2401 |    | 0.2765 | 0.2559 |
|      | 0.2507 | 0.2085 |     | 0.2593 | 0.2243 |    | 0.2679 | 0.2401 |
| LC   | 0.2730 | 0.2579 | LE  | 0.2801 | 0.2705 | LG | 0.2871 | 0.2831 |
|      | 0.2801 | 0.2705 |     | 0.2871 | 0.2831 |    | 0.2937 | 0.2950 |
|      | 0.2836 | 0.2685 |     | 0.2906 | 0.2811 |    | 0.2972 | 0.2930 |
|      | 0.2765 | 0.2559 |     | 0.2836 | 0.2685 |    | 0.2906 | 0.2811 |
| LI   | 0.2937 | 0.2950 |     |        |        |    |        |        |
|      | 0.3002 | 0.3070 |     |        |        |    |        |        |

Table 1-10 Bin Range of Chromaticity Coordinates Block (IF=20mA ;Ta=25 )

|      |        |        |     |        |        |     |        |        |
|------|--------|--------|-----|--------|--------|-----|--------|--------|
| LR1  | 0.2386 | 0.2021 | LR2 | 0.2446 | 0.2144 | LR3 | 0.2506 | 0.2268 |
|      | 0.2446 | 0.2144 |     | 0.2506 | 0.2268 |     | 0.2565 | 0.2391 |
|      | 0.2501 | 0.2114 |     | 0.2561 | 0.2238 |     | 0.2620 | 0.2361 |
|      | 0.2441 | 0.1991 |     | 0.2501 | 0.2114 |     | 0.2561 | 0.2238 |
| LR4  | 0.2565 | 0.2391 | LR5 | 0.2625 | 0.2515 | LR6 | 0.2685 | 0.2638 |
|      | 0.2625 | 0.2515 |     | 0.2685 | 0.2638 |     | 0.2745 | 0.2762 |
|      | 0.2680 | 0.2485 |     | 0.2740 | 0.2608 |     | 0.2800 | 0.2732 |
|      | 0.2620 | 0.2361 |     | 0.2680 | 0.2485 |     | 0.2740 | 0.2608 |
| LR7  | 0.2745 | 0.2762 | LR8 | 0.2805 | 0.2885 | LR9 | 0.2865 | 0.3009 |
|      | 0.2805 | 0.2885 |     | 0.2865 | 0.3009 |     | 0.2924 | 0.3132 |
|      | 0.2860 | 0.2855 |     | 0.2920 | 0.2979 |     | 0.2979 | 0.3102 |
|      | 0.2800 | 0.2732 |     | 0.2860 | 0.2855 |     | 0.2920 | 0.2979 |
| LR10 | 0.2924 | 0.3132 | TB0 | 0.2510 | 0.2113 | TB1 | 0.2575 | 0.2232 |
|      | 0.2984 | 0.3256 |     | 0.2575 | 0.2232 |     | 0.2639 | 0.2352 |
|      | 0.3039 | 0.3226 |     | 0.2626 | 0.2202 |     | 0.2690 | 0.2322 |
|      | 0.2979 | 0.3102 |     | 0.2562 | 0.2082 |     | 0.2626 | 0.2202 |
| TB2  | 0.2639 | 0.2352 | TB3 | 0.2704 | 0.2471 | TB4 | 0.2768 | 0.2591 |
|      | 0.2704 | 0.2471 |     | 0.2768 | 0.2591 |     | 0.2833 | 0.2710 |
|      | 0.2755 | 0.2441 |     | 0.2819 | 0.2561 |     | 0.2884 | 0.2680 |
|      | 0.2690 | 0.2322 |     | 0.2755 | 0.2441 |     | 0.2819 | 0.2561 |
| TB5  | 0.2833 | 0.2710 | LH1 | 0.2573 | 0.2073 | LH2 | 0.2638 | 0.2192 |
|      | 0.2897 | 0.2829 |     | 0.2638 | 0.2192 |     | 0.2702 | 0.2311 |
|      | 0.2948 | 0.2799 |     | 0.2689 | 0.2162 |     | 0.2754 | 0.2281 |
|      | 0.2884 | 0.2680 |     | 0.2624 | 0.2043 |     | 0.2689 | 0.2162 |
| LH3  | 0.2702 | 0.2311 | LH4 | 0.2767 | 0.2431 | LH5 | 0.2832 | 0.2550 |
|      | 0.2767 | 0.2431 |     | 0.2832 | 0.2550 |     | 0.2896 | 0.2669 |
|      | 0.2818 | 0.2401 |     | 0.2882 | 0.2520 |     | 0.2947 | 0.2639 |
|      | 0.2754 | 0.2281 |     | 0.2818 | 0.2401 |     | 0.2882 | 0.2520 |
| LH6  | 0.2896 | 0.2669 | LH7 | 0.2960 | 0.2789 | LH8 | 0.3025 | 0.2908 |
|      | 0.2960 | 0.2789 |     | 0.3025 | 0.2908 |     | 0.3090 | 0.3027 |
|      | 0.3011 | 0.2759 |     | 0.3076 | 0.2878 |     | 0.3141 | 0.2997 |
|      | 0.2947 | 0.2639 |     | 0.3011 | 0.2759 |     | 0.3076 | 0.2878 |
| O1   | 0.2688 | 0.2163 | O2  | 0.2753 | 0.2282 | O3  | 0.2817 | 0.2401 |
|      | 0.2753 | 0.2282 |     | 0.2817 | 0.2401 |     | 0.2882 | 0.2521 |
|      | 0.2804 | 0.2252 |     | 0.2869 | 0.2371 |     | 0.2933 | 0.2491 |
|      | 0.2739 | 0.2133 |     | 0.2804 | 0.2252 |     | 0.2869 | 0.2371 |
| O4   | 0.2882 | 0.2521 | O5  | 0.2947 | 0.2640 | O6  | 0.3011 | 0.2759 |
|      | 0.2947 | 0.2640 |     | 0.3011 | 0.2759 |     | 0.3075 | 0.2879 |
|      | 0.2997 | 0.2610 |     | 0.3062 | 0.2729 |     | 0.3126 | 0.2849 |
|      | 0.2933 | 0.2491 |     | 0.2997 | 0.2610 |     | 0.3062 | 0.2729 |
| O7   | 0.3075 | 0.2879 |     |        |        |     |        |        |
|      | 0.3140 | 0.2998 |     |        |        |     |        |        |
|      | 0.3191 | 0.2968 |     |        |        |     |        |        |
|      | 0.3126 | 0.2849 |     |        |        |     |        |        |

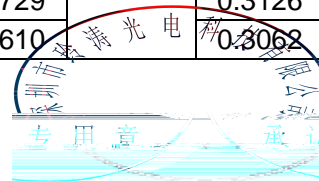

Fig. 1-11 The C.I.E. 1931 Chromaticity Diagram: ( LB2&K )

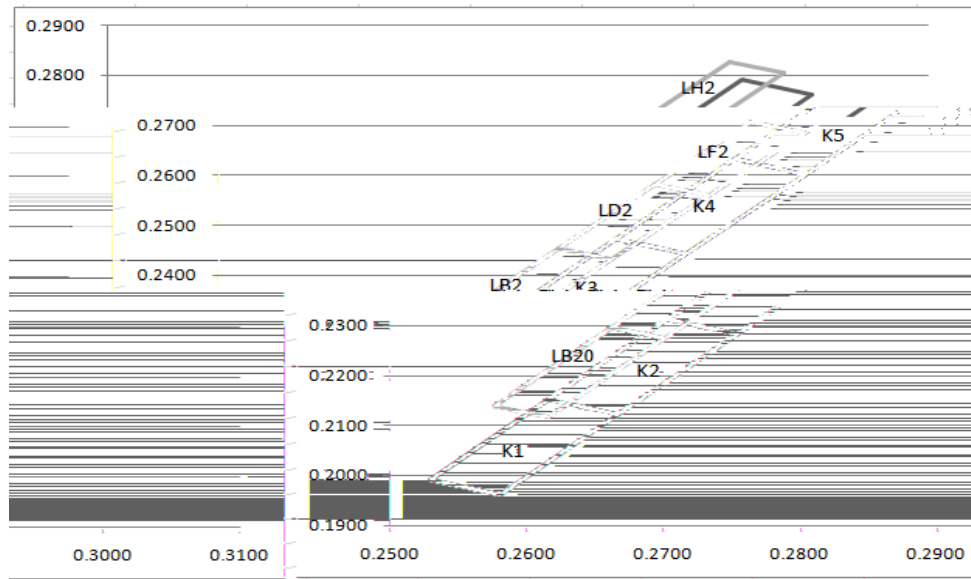
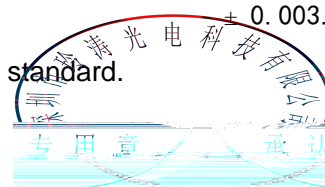

Table 1-12 Bin Range of Chromaticity Coordinates Block ( IF=20mA ; Ta=25 )

|      |        |        |     |        |        |     |        |        |
|------|--------|--------|-----|--------|--------|-----|--------|--------|
| LB20 | 0.2576 | 0.2139 | LB2 | 0.2662 | 0.2297 | LD2 | 0.2748 | 0.2455 |
|      | 0.2662 | 0.2297 |     | 0.2748 | 0.2455 |     | 0.2819 | 0.2581 |
|      | 0.2701 | 0.2275 |     | 0.2787 | 0.2433 |     | 0.2858 | 0.2559 |
|      | 0.2615 | 0.2117 |     | 0.2701 | 0.2275 |     | 0.2787 | 0.2433 |
| LF2  | 0.2819 | 0.2581 | LH2 | 0.2889 | 0.2707 | K1  | 0.2529 | 0.1992 |
|      | 0.2889 | 0.2707 |     | 0.2955 | 0.2826 |     | 0.2616 | 0.2152 |
|      | 0.2928 | 0.2685 |     | 0.2994 | 0.2804 |     | 0.2667 | 0.2122 |
|      | 0.2858 | 0.2559 |     | 0.2928 | 0.2685 |     | 0.2580 | 0.1962 |
| K2   | 0.2616 | 0.2152 | K3  | 0.2703 | 0.2312 | K4  | 0.2790 | 0.2472 |
|      | 0.2703 | 0.2312 |     | 0.2790 | 0.2472 |     | 0.2877 | 0.2632 |
|      | 0.2754 | 0.2282 |     | 0.2841 | 0.2442 |     | 0.2928 | 0.2602 |
|      | 0.2667 | 0.2122 |     | 0.2754 | 0.2282 |     | 0.2841 | 0.2442 |
| K5   | 0.2877 | 0.2632 |     |        |        |     |        |        |
|      | 0.2964 | 0.2792 |     |        |        |     |        |        |
|      | 0.3015 | 0.2762 |     |        |        |     |        |        |
|      | 0.2928 | 0.2602 |     |        |        |     |        |        |

Notes

- 1 Measurement uncertainty of the color coordinates:  $\pm 0.003$ .
- 2 The new white dustbin refers to the application of small backlight standard.



## 1.7 Typical Optical Characteristics Curves

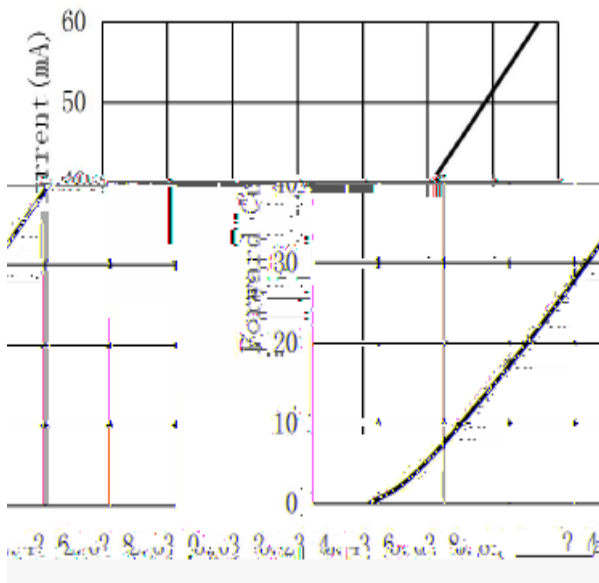

Fig. 1-13 Forward Voltage Vs Forward Current

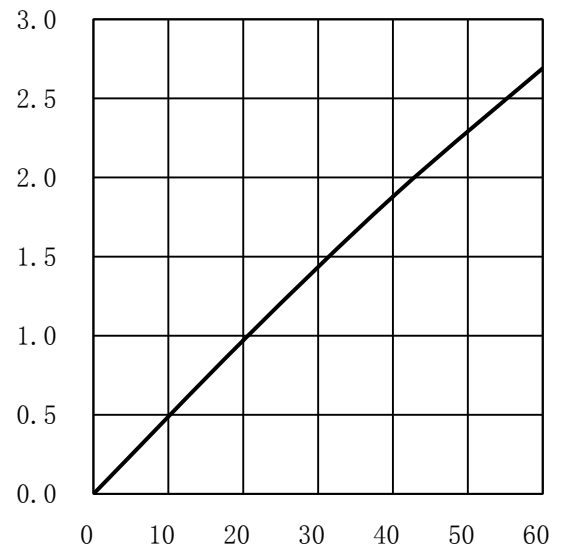

Fig. 1-14 Forward Current Vs Relative Intensity

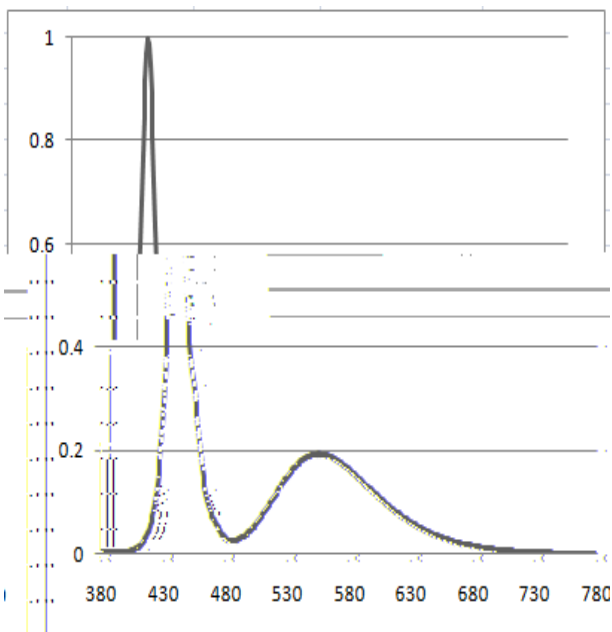

Fig. 1-16 Spectrum Distribution

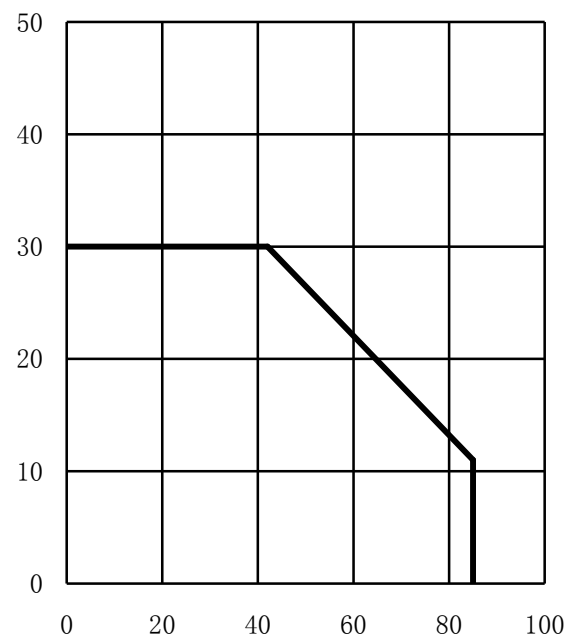
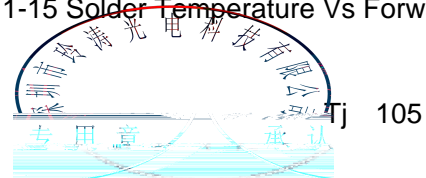

Fig. 1-15 Solder Temperature Vs Forward Current



## 2. Packaging

### 2.1 Packaging Specification

Package:5000pcs/reel.                      5000pcs

#### 2.1.1 Carrier Tape Dimension

|    |           |    |           |    |           |    |           |    |           |
|----|-----------|----|-----------|----|-----------|----|-----------|----|-----------|
| P0 | 4.00±0.10 | P2 | 2±0.05    | P1 | 4.00±0.10 | D0 | 1.50±0.10 | D1 | 0.65±0.10 |
| E  | 1.75±0.10 | F  | 3.50±0.10 | W  | 8.00±0.20 | A0 | 0.95±0.10 | T  | 0.20±0.10 |

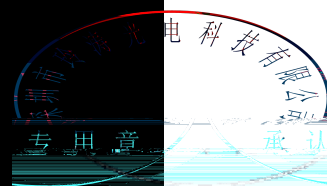

## 2.1.2 Label Form Specification

Table 2-2 Label Map



Table 2-3 Label Form Specification

| PART NO.       | Part Number        |
|----------------|--------------------|
| BIN CODE       | Bin Code           |
| IV             | Luminous intensity |
| V <sub>F</sub> | Forward Voltage    |
| WL             | Wavelength         |
| QTY            | Packing Quantity   |
| DATE           | Made Date          |
| LOT NO         | Lot Number         |

## 2.2 Moisture Resistant Packing

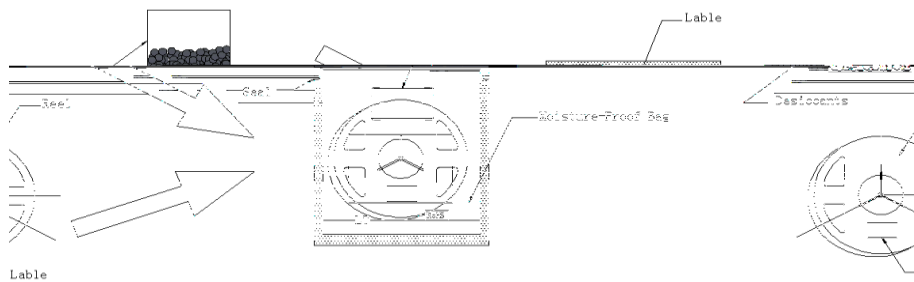

Fig.2-4 Moisture Resistant Packing

## 2.3 Cardboard Box

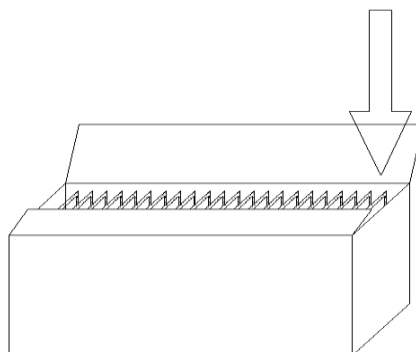
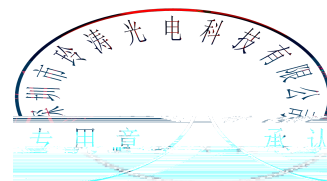

Fig.2-5 Cardboard Box



## 2.4 Reliability Test Items And Conditions

Table 2-6 Reliability Test Items And Conditions

| Test Items                            | Test Condition             | Time      | Quantity | Ac/Re / |
|---------------------------------------|----------------------------|-----------|----------|---------|
| Reflow                                | Temp:260 max<br>T=10 sec   | ---       | 20pcs.   | 0/1     |
| Thermal Shock                         | -40 20min 10s<br>100 20min | 100 cycle | 20pcs.   | 0/1     |
| High Temperature Storage              | Temp:100                   | 1000hrs.  | 20pcs.   | 0/1     |
| Low Temperature Storage               | Temp:-40                   | 1000hrs.  | 20pcs.   | 0/1     |
| Life Test                             | Ta=25<br>If=20mA           | 1000hrs.  | 20pcs.   | 0/1     |
| High Temperature and Humidity storage | 60 / 90%RH                 | 1000hrs.  | 20pcs.   | 0/1     |
| Temperature Humidity Operation Life   | 60 / 90%RH<br>If=15mA      | 500hrs    | 20pcs.   | 0/1     |

## 2.5 Criteria For Judging Damage

Table 2-7 Criteria For Judging Damage

| Test Items      | Symbol         | Test Condition       | Criteria For Judgement |              |
|-----------------|----------------|----------------------|------------------------|--------------|
|                 |                |                      | Min.                   | Max.         |
| Forward Voltage | V <sub>F</sub> | I <sub>F</sub> =20mA |                        |              |
| Reverse Current | I <sub>R</sub> | V <sub>R</sub> = 5V  |                        | >U.S.L*)x2.0 |

|               |  |                   |                       |   |
|---------------|--|-------------------|-----------------------|---|
| Luminous Flux |  | $I_F=20\text{mA}$ | $<L.S.L^*)\times 0.7$ | - |
|---------------|--|-------------------|-----------------------|---|

Notes

- 1.U.S.L: Upper standard level                      L.S.L: Lower standard level
- 2.The above reliability tests is based on the verification of a single/strip LED of LT existing experimental platform,the reliability experiment was taken under good heat dissipation conditions. when customer



|  |       |                                 |          |               |
|--|-------|---------------------------------|----------|---------------|
| Preheating: Time   | Tsmin | Tsmax                           | 60 - 120 | 60s-120s      |
| Time limited to maintain high temperature: the temperature |       | (TL)                            | 217 °C   |               |
| Time limited to maintain high temperature: The Time        |       | (tL)                            | 60       | Max 60s       |
| Peak /Classification of temperature: /                     |       | (TP)                            | 260 °C   |               |
| Time limit classification of peak temperature time         |       | tp                              | 10       | Max 10s       |
| (TP) 5 °C  |       | Hold time within 5 ° C with the | 30       | Max 30s       |
| actual peak temperature (TP)                               |       |                                 |          |               |
| Cooling speed  |       |                                 | 6 °C/    | Max 6 °C/ s   |
| 25 °C  |       | Needed time from 25 °C to Tp    | 8        | Max 8 minutes |

#### Notes

(1)Reflow soldering should not be done more than twice. If more than 24 hours between the two solderings , LED will be damaged. 24 LED

(2)Whensoldering , do not put stress on the LEDs during heating.

#### 3.1.1 Soldering Iron

(1) When do soldering by hand, keep the temperature of iron below less 300°C less than 3 seconds. , 300 3

(2) Soldering by hand should be done only one time.

#### 3.1.2 Repairing

Repairing should not be done after the LEDs have been soldered. When repairing is unavoidable, a double-head soldering iron should be used (as below figure). It should be confirmed in advance whether the characteristics of LEDs will or not be damaged by repairing.

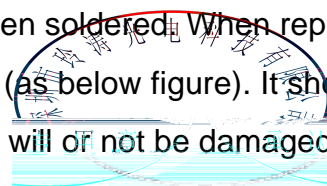

LED

LED

### 3.1.3 Cautions

(1) The encapsulated material of the LEDs is silicone. Therefore the LEDs have a soft surface on the top of package. The pressure to the top surface will be impacted on the reliability of the LEDs. Precautions should be taken to avoid the strong pressure on the encapsulated part. So when use the picking up nozzle, the pressure on the silicone resin should be proper. LED

LED

(2) 2)

900PPM

900PPM

1500PPM.

(3) VOCs (Volatile organic compounds) emitted from materials used in the construction of fixtures can penetrate silicone encapsulants of LEDs and discolor when exposed to heat and photonic energy. The result can be a significant loss of light output from the fixture. Knowledge of the properties of the materials selected to be used in the construction of fixtures can help prevent these issues. LT advises against the use of any chemicals or materials that have been found or are suspected to have an adverse effect on device performance or reliability. To verify compatibility, LT recommends that all chemicals and materials be tested in the specific application and environment for which th

LED

(7) Compared to standard encapsulants, silicone is generally softer, and the surface is more likely to attract dust, requiring special care during processing. In cases where a minimal level of dirt and dust particles cannot be guaranteed, a suitable cleaning solution must be applied to the surface after the soldering of components. LT suggests using isopropyl alcohol for cleaning. In case other solvents are used, it must be assured that these solvents do not dissolve the package or resin. Ultrasonic cleaning is not recommended. Ultrasonic cleaning may cause damage to the LED.

LED

Table 4-1 Storage

| Conditions |                             | Temperature | Humidity | Time                    |
|------------|-----------------------------|-------------|----------|-------------------------|
| Storage    | Before Opening Aluminum Bag | 30          | 75%      | Within 1 Year From Date |
|            | After Opening Aluminum Bag  | 30          | 60%      | 24hours<br>24           |
| Baking     |                             | 60± 5       | -        | 24hours<br>24           |

(8) If the moisture absorbent material ( silica gel ) has faded away or the LEDs have exceeded the storage time, baking treatment should be performed after unpacking and based on the following condition ( 65±5 ) °C for above 24 hours.

60± 5

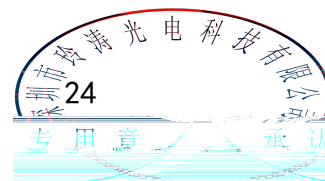

If the package is flatulence or damaged, please notify the sales staff to assist.

(9) Similar to most Solid state devices; LEDs are sensitive to Electro-Static Discharge (ESD) and Electrical Over Stress (EOS).

LED

