

SPECIFICATION

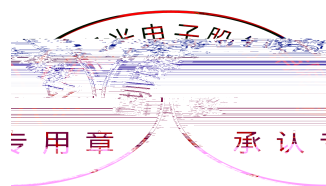

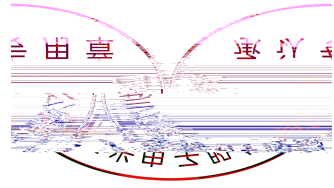

1. Description

1.1 General Description



1.2 Features



1.3 Application

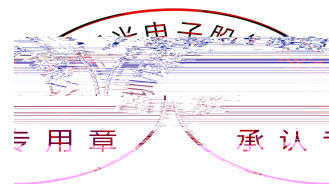

1.4 Package Dimension

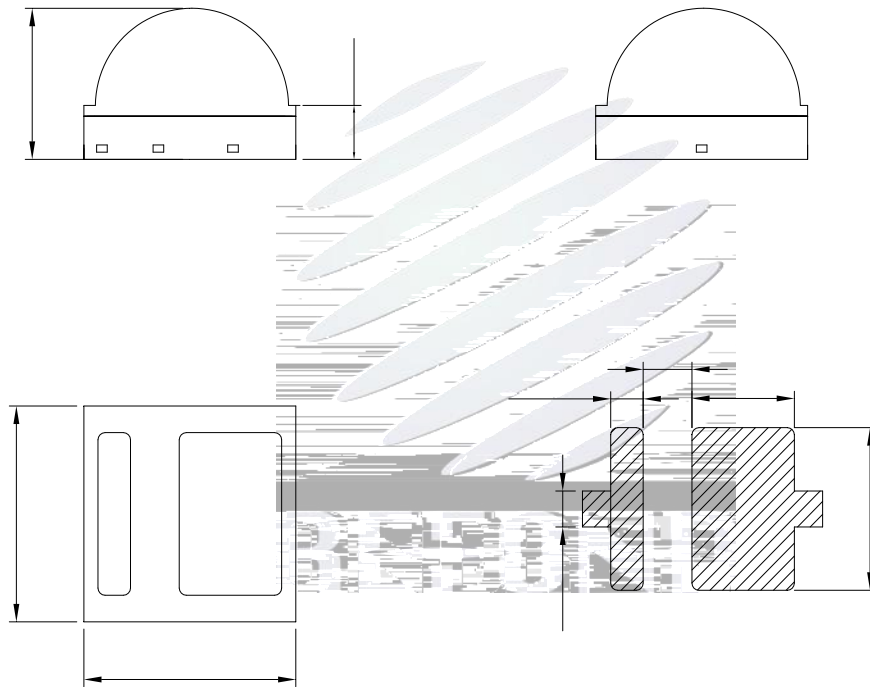
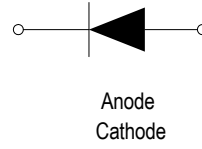
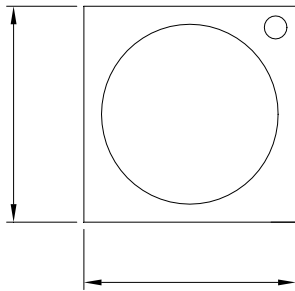

±

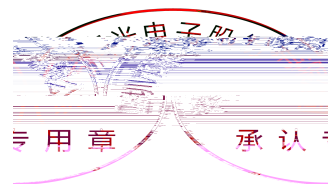

1.5 Product Parameters

	λ					

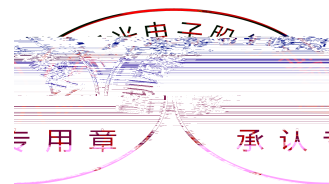
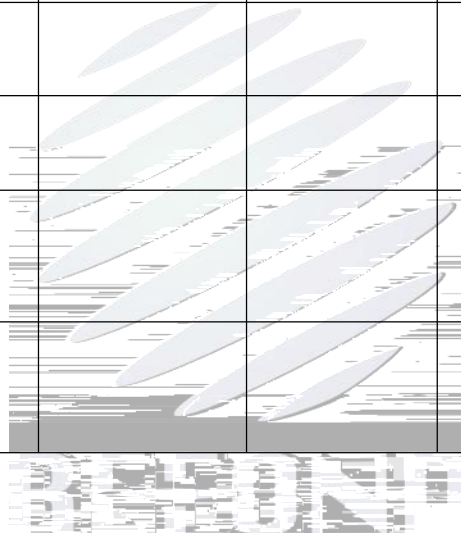



1.6 Typical optical characteristics curves

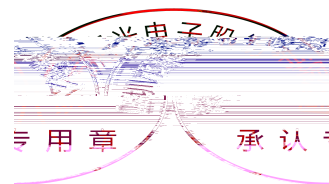
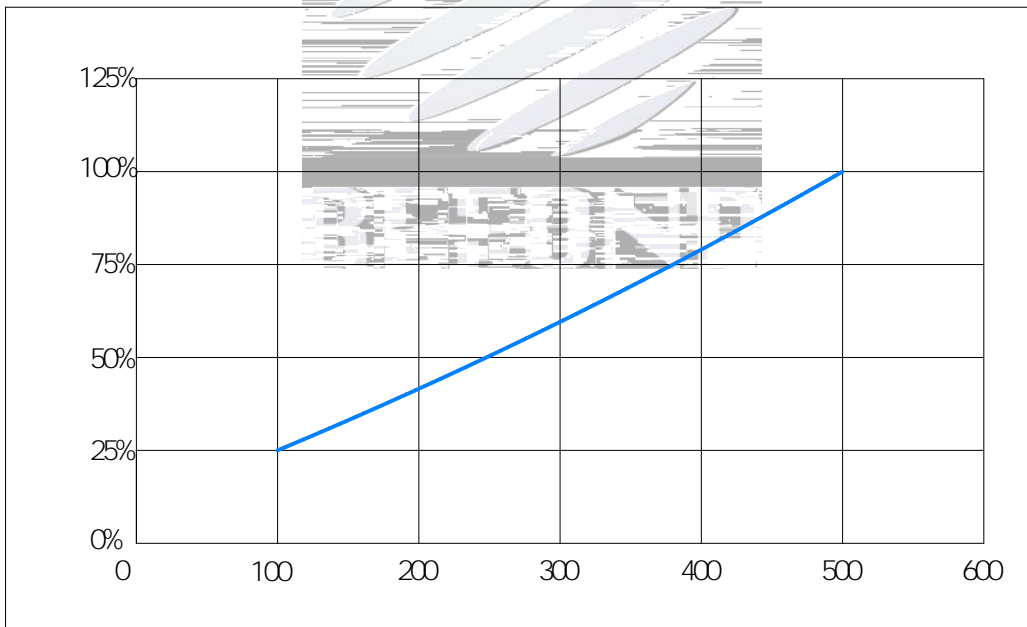
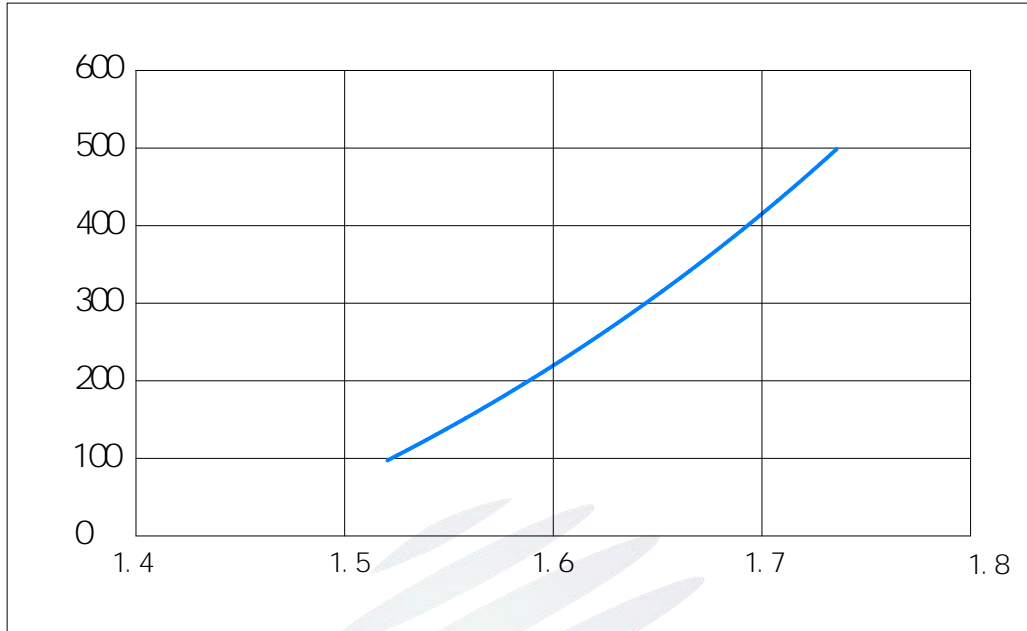

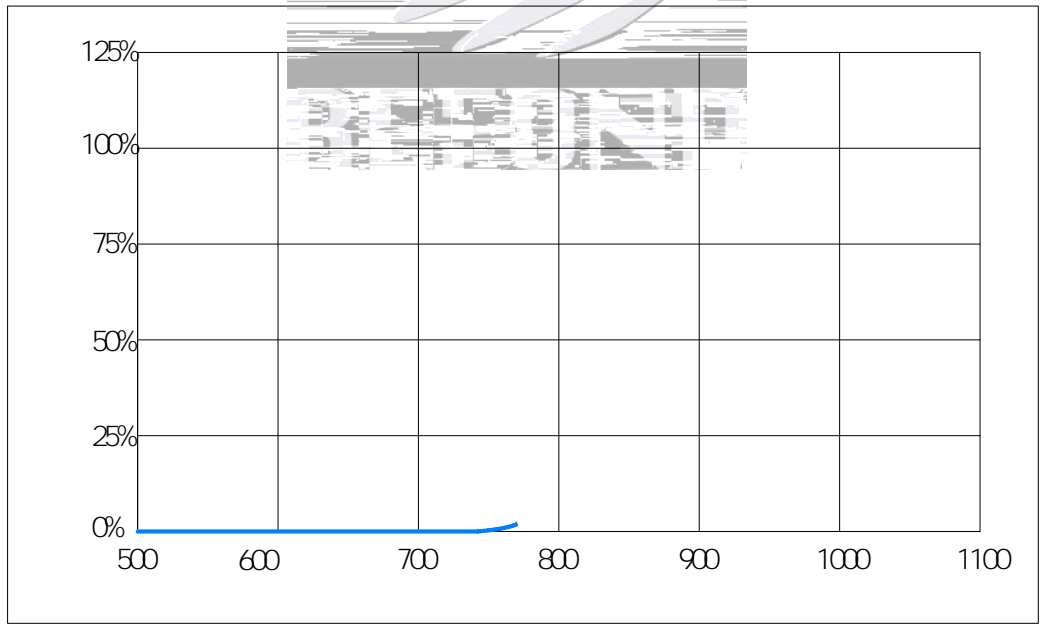
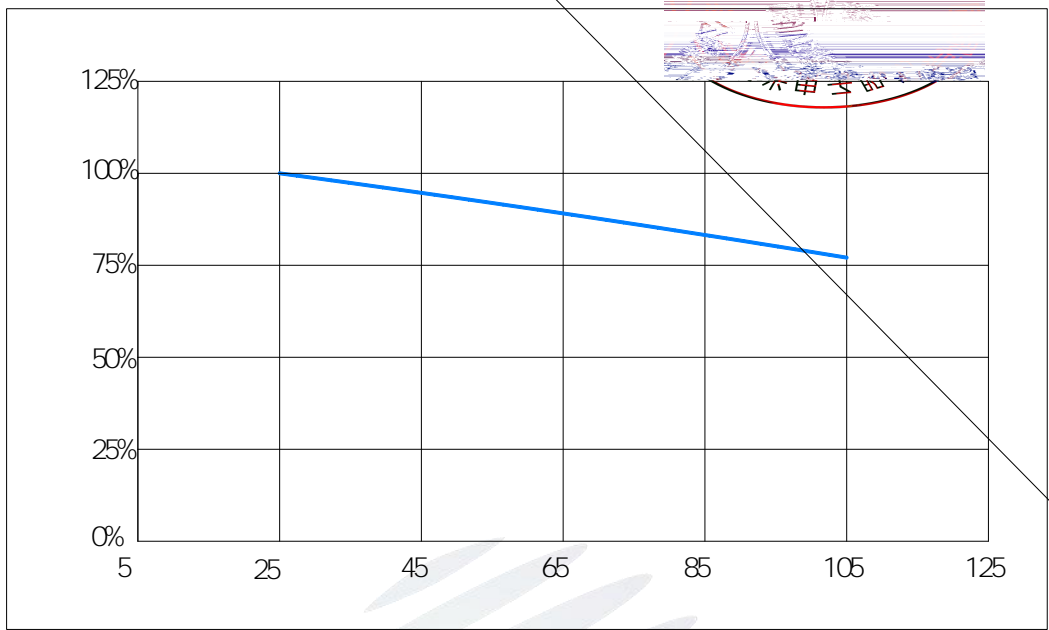
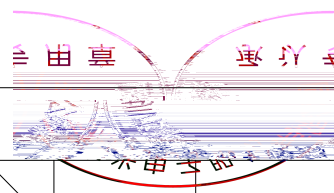

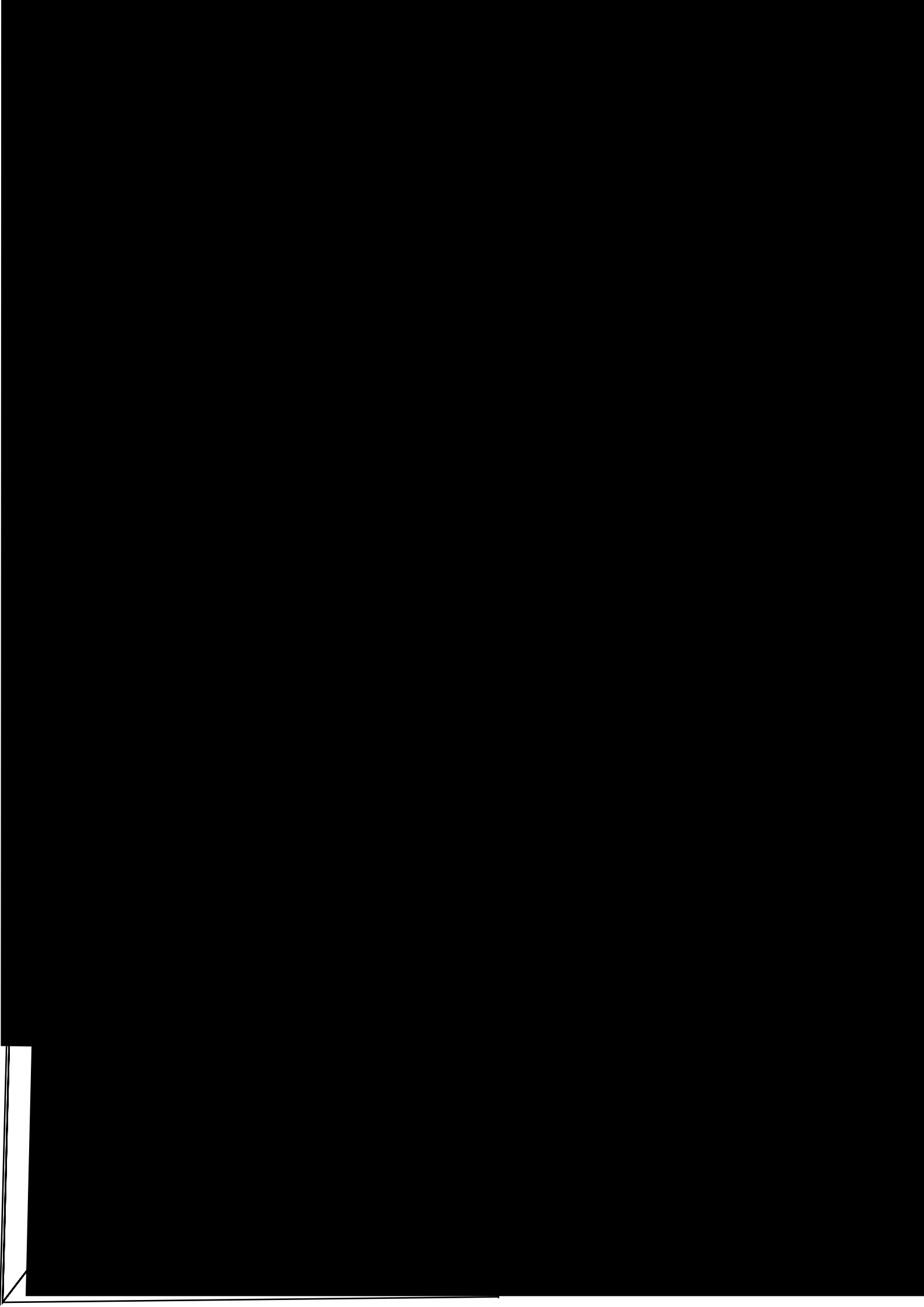



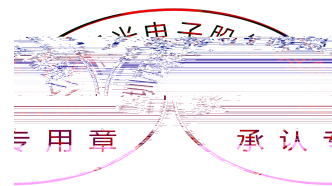
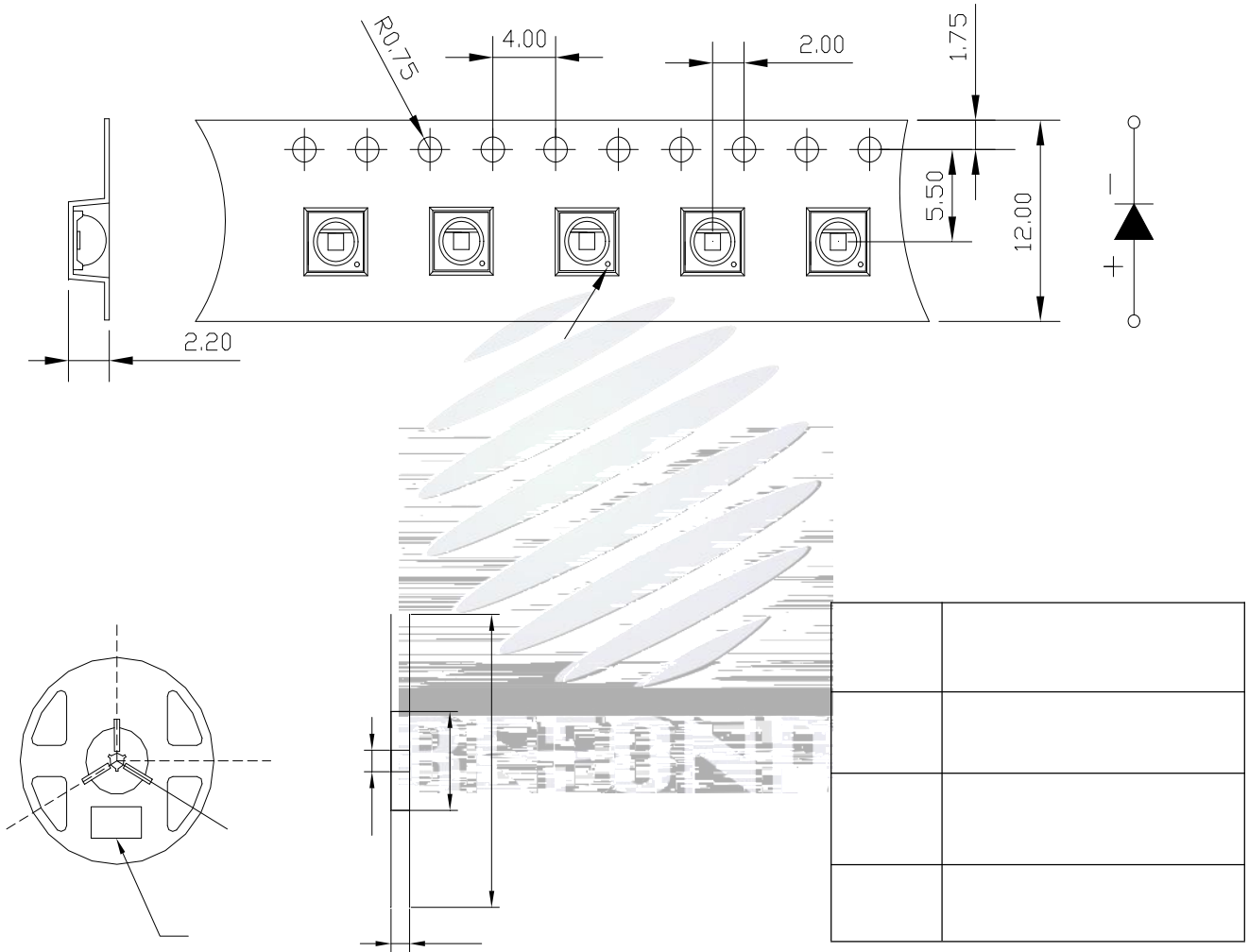

2. Packaging

2.1 Packaging Specification



PART NO. 
SPEC NO. 
LOT NO. 

BIN CODE
e WLP
VF

QTY:
DATE:

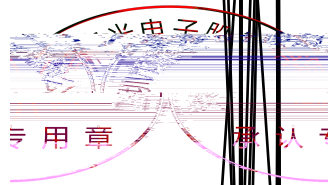
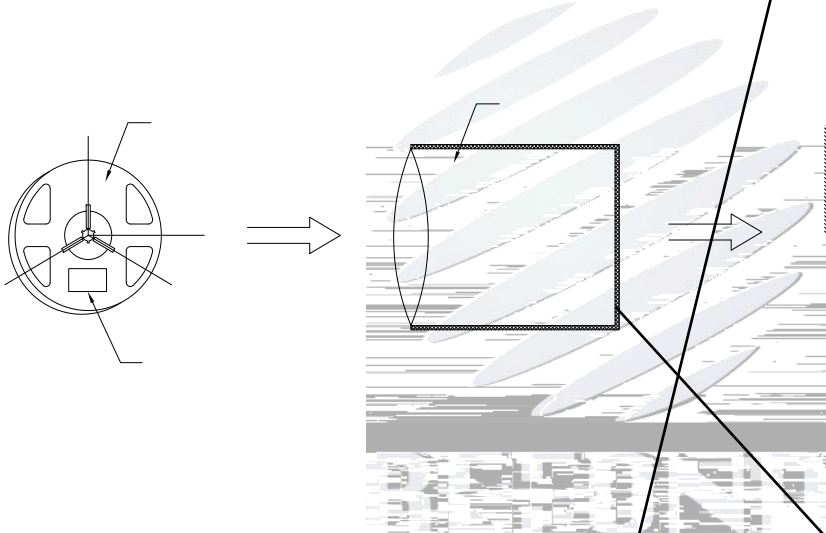

2.4 Reliability Test Items And Conditions

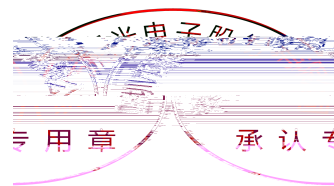

2.5 Criteria For Judging Damage

1.

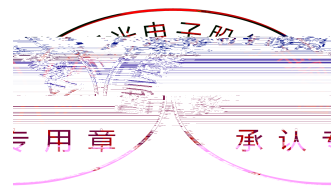

3. SMT Reflow Soldering Instructions

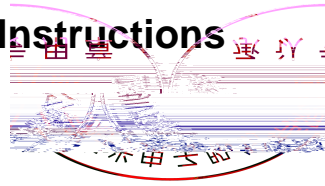

3.1 SMT Reflow Soldering Instructions



°C

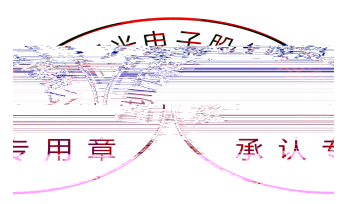

4. Handling Precautions

4.1 Handling Precautions

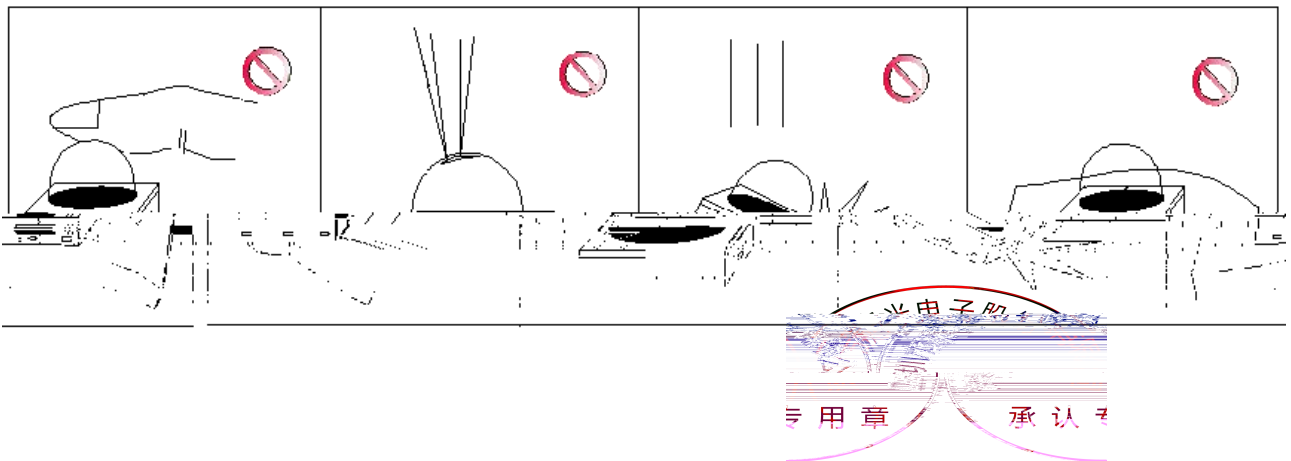



		士		

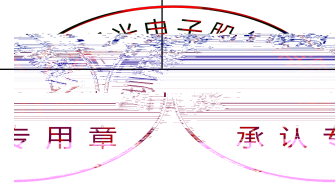

(7) () (±) °C

