

SPECIFICATION

产品规格书



R&D 研发

Mass Production 量产供货



Contents 目錄

- 1. Description 产品介绍
- 1.1 General Description 产品描述
- 1.2 Features 产品特征
- 1.3 Application 应用领域
- 1.4 Package Dimension 封装尺寸
- 1.5 Product Parameters 产品参数
- 1.6 Bin Range Of Forward Voltage and Luminous Intensity and Dominant wavelength (IF=20mA) 电压与发光强度与主波长分 BIN 范围(IF=20mA)
- 1.7 Typical Optical Characteristics Curves 典型光学特性曲线

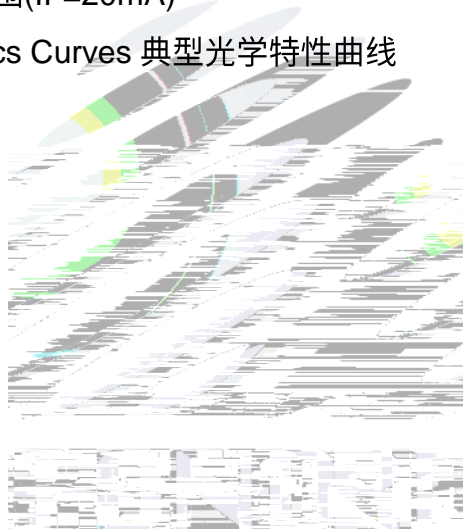

1. Description 产品介绍

1.1 General Description 产品描述



The Red source color devices are made with AlGaInP on Substrate Light Emitting Diode
Product Package: 2.2mmX1.4mmX1.3mm.

该红光 LED 由 AlGaInP 四种元素芯片激发而成，产品尺寸：2.2mmX1.4mmX1.3mm。

1.2 Features 产品特征

PLCC Package. PLCC 封装

Extremely wide viewing angle. 发光角度大

Suitable for all SMT assembly and solder process. 适用于所有的 SMT 组装和焊接工艺

Available on tape and reel. 适用于载带及卷轴

Moisture sensitivity level: Level 2. 防潮等级 Level 2

Compliance with RoHS and REACH. 符合 RoHS 和 REACH 要求

Qualifications: The product qualification test plan is based on the guidelines of AEC-Q101
Stress Test Qualification for Automotive Grade Discrete Semiconductors 资格：产品资格测试计划基于 AEC-Q101 汽车级分立半导体应力测试资格准则

1.3 Application 产品应用

Automotive Lighting Interior. 汽车内饰照明



1.4 Package Dimension 封装尺寸

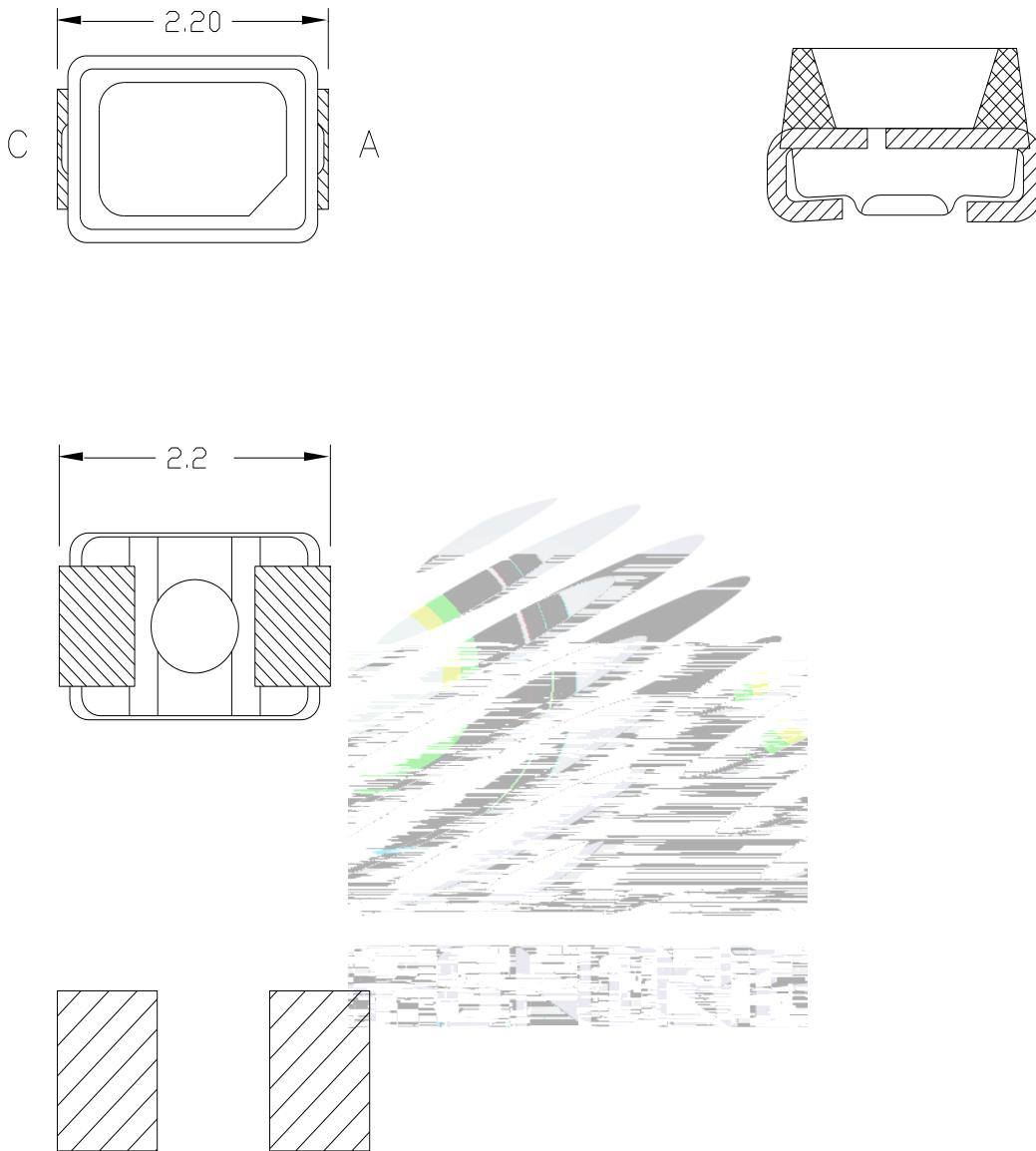

Notes 备注:

1. All dimensions units are millimeters. 所有尺寸标注单位为毫米
2. All dimensions tolerances are 0.20mm unless otherwise noted. 除特别标注外, 所有尺寸公差为±0.20 毫米



Notes 备注:

1. 1/10 Duty cycle, 10ms pulse width. 脉宽10ms,占空比1/10.
2. The above forward voltage measurement allowance tolerance is $\pm 0.1V$. 以上所示电压测量误差 $\pm 0.1V$.
3. The above color coordinates measurement allowance tolerance is ± 0.005 . 以上所示坐标测量误差 ± 0.005 .
4. The above luminous intensity measurement allowance tolerance $\pm 10\%$. 上述发光强度的测试允许公差为 $\pm 10\%$.
5. Care is to be taken that power dissipation does not exceed the absolute maximum rating of the product. 使用功率不能超过规定的最大值。
6. All measurements were made under the standardized environment of Refond. 所有测试都是基于标准测试平台。
7. When the LEDs are in operation the maximum current should be decided after measuring the package temperature, junction temperature should not exceed the maximum rate. LED 使用的最大电流需要根据散热条件确定, 结温不能超过最大值。
8. ESD yield is over 90% at 2000V ESD (HBM). ESD protection during products handing is needed. 90%的LED 通过人体模式ESD2000V测试, 在操作时请注意静电防护。

1.6Bin Range Of Forward Voltage and Luminous Intensity and Dominant wavelength (IF=20mA)电压与发光强度与主波长分 BIN 范围(IF=20mA)

Table 1-3

V _F (V)	B1	B2	C1	C2	D1	D2
	1.8-1.9	1.9-2.0	2.0-2.1	2.1-2.2	2.2-2.3	2.3-2.4
IV (mcd)	K1	K2	L1			
	530-650	650-800	800-1000			
WD(nm)	F2	G1	G2			
	627.5-630	630-632.5	632.5-635			





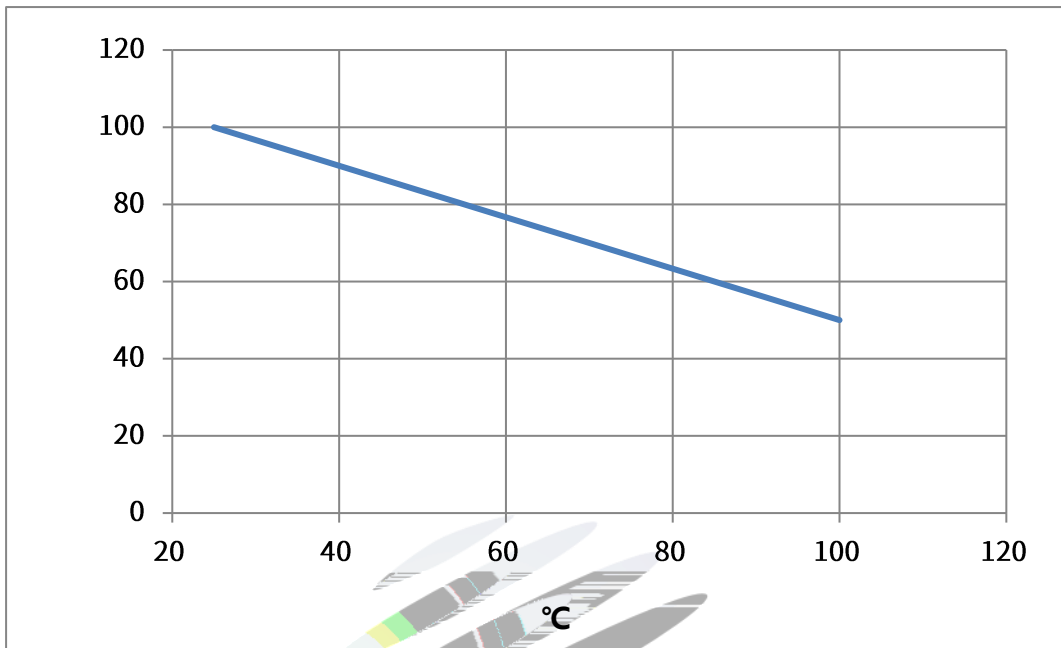
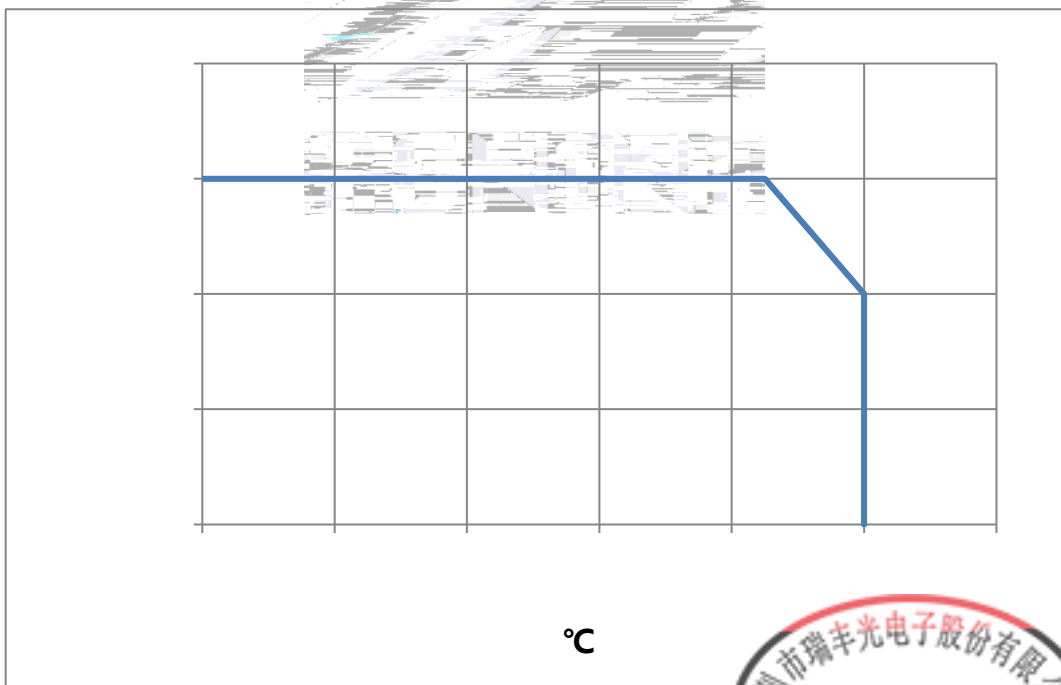

Fig. 1-8 Solder Temperature Vs Relative Intensity 管脚温度与相对光强特性曲线



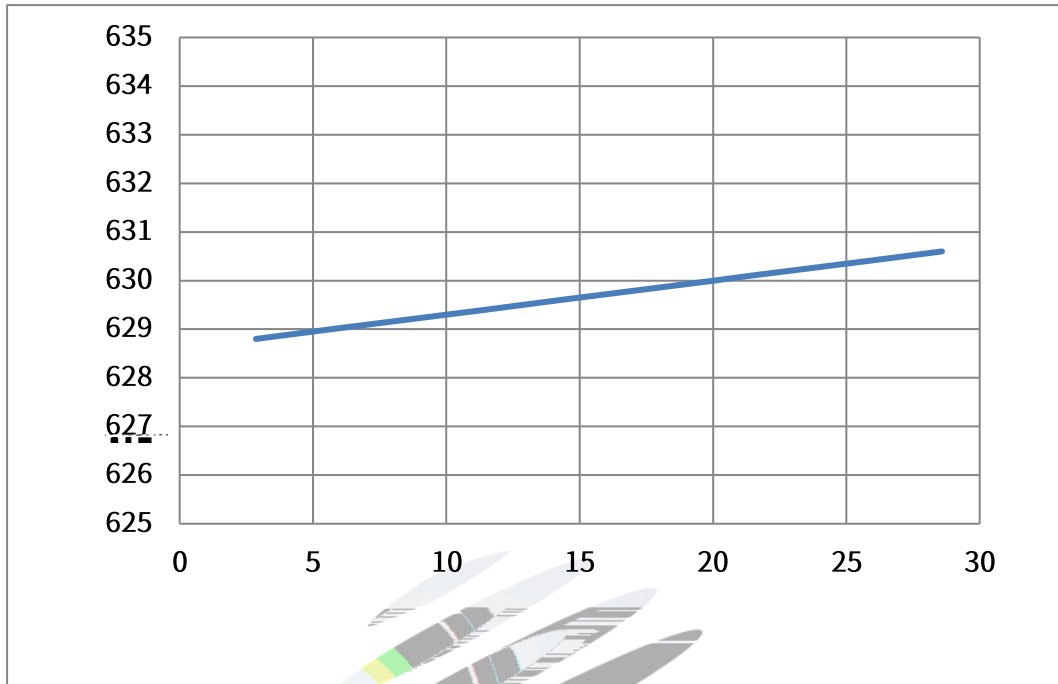

Fig. 1-12 Forward current VS Dominate wavelength 正向电流与主波长特性曲线 (Ts=25°C)

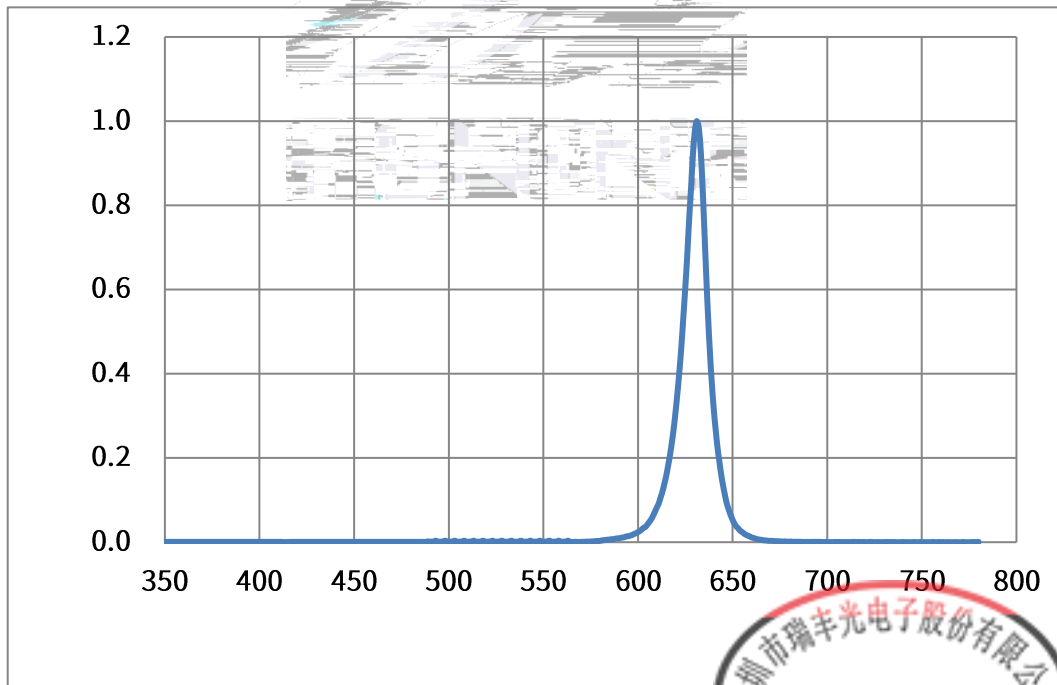
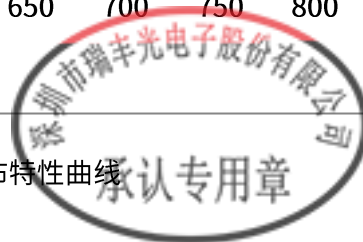

Fig. 1-13 Spectrum Distribution 光谱分布特性曲线



2. Packaging 产品包装

2.1 Packaging Specification 包装规格

Package:3000pcs/reel.包装每卷 。

2.1.1 Carrier Tape Dimension 载带尺寸

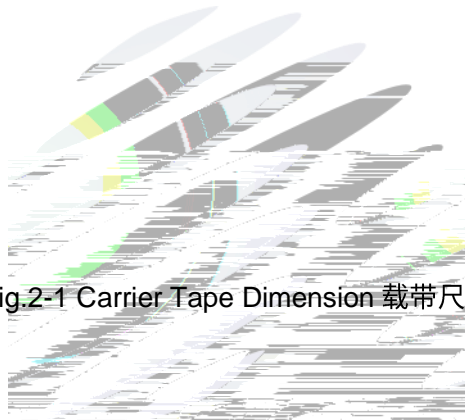
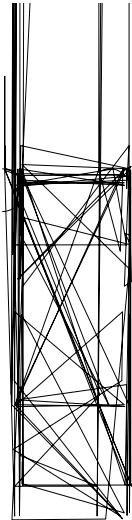

Fig.2-1 Carrier Tape Dimension 载带尺寸

2.1.2 Reel Dimension 卷盘尺寸

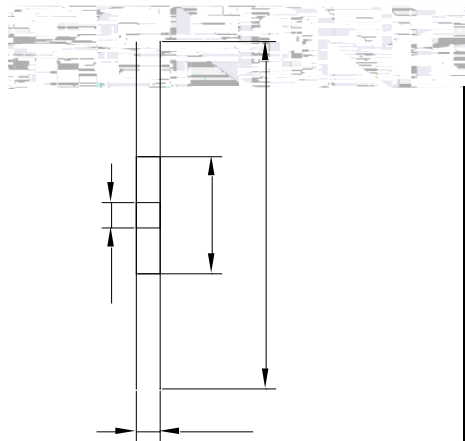
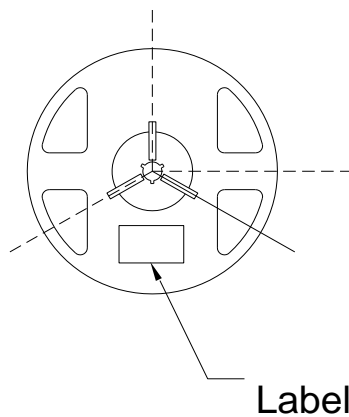

Table 2-1 Reel Dimension 卷盘尺寸

A	8.0±0.1mm
B	178.0±1.0mm
C	60.0±1.0mm
D	13.0±0.5mm

Fig.2-2 Reel Dimension 卷盘尺寸

Notes 备注:

The tolerances unless mentioned ±0.1mm. Unit : mm 注: 未注公差为±0.1毫米, 尺寸单位: 毫米。



2.1.3 Label Form Specification 标签规格

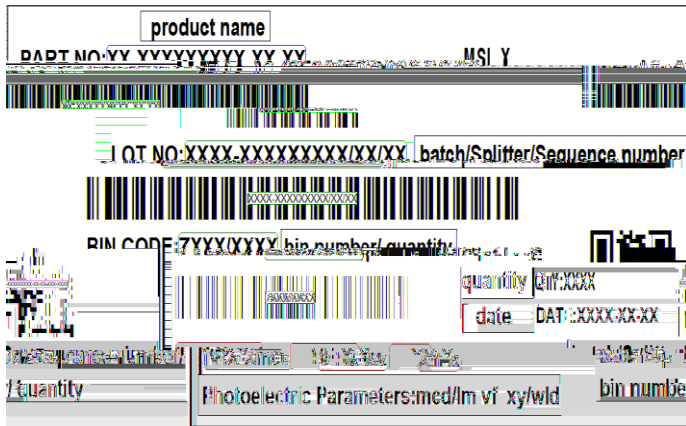

Fig. 2-3 Label Form Specification 标签规格

Table 2-2 Specification 规格

PART NO.	Part Number 品名
SPEC NO.	Spec Number 规格
LOT NO.	Lot Number 批次号
BIN CODE	Bin Code 参数代码
IV	Luminous Intensity 发光强度
XY	Chromaticity Bin 色区
V _F	Forward Voltage 正向电压
WLD	Wavelength 波长代码
QTY	Packing Quantity 数量
DATE	Made Date 生产日期

2.2 Moisture Resistant Packing 防潮包装

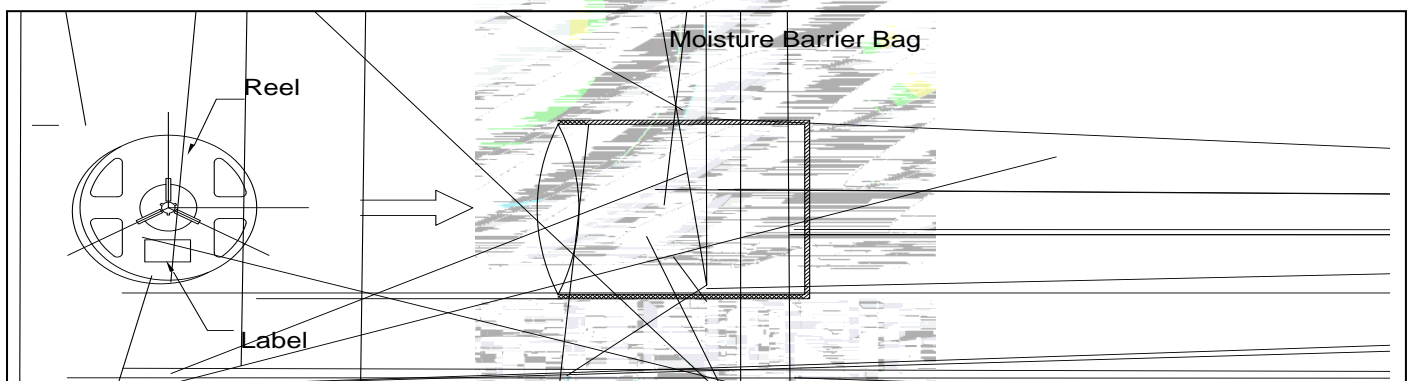

Fig.2-4 Moisture Resistant Packing 防潮包装

2.3 Cardboard Box 包装纸箱

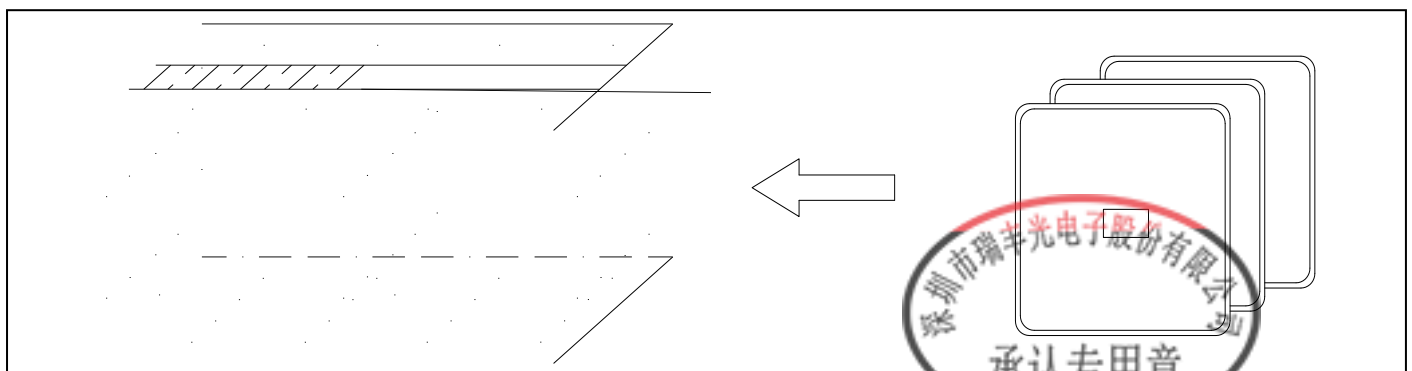

Fig.2-5 Cardboard Box 包装纸箱

2.5 Criteria For Judging Damage 失效判定标准

Table 2-4 Criteria For Judging Damage 失效判定标准

Test Items 项目	Symbol 符号	Test Condition 测试条件	Criteria For Judgement 判定标准	
			Min. 最小	Max. 最大
Forward Voltage 正向电压	V_F	$I_F=20mA$	-	U.S.L*)x1.1
Reverse Current 反向电流	I_R	$V_R = 5V$	-	U.S.L*)x2.0
Luminous Intensity 发光强度	IV	$I_F=20mA$	L.S.L*)x0.7	-

Notes 备注:

- 1.U.S.L: Upper standard level 规格上限 L.S.L: Lower standard level 规格下限
- 2.The above reliability tests is based on the verification of a single/strip LED of Refond's existing experimental Platform, the reliability experiment was taken under good heat dissipation conditions. When customers applies The LED to the series and parallel circuit, should take consideration of all the factors such as the current, Voltage distribution, heat dissipation and others.以上可靠性测试是基于瑞丰现有实验平台单颗/条 LED 在良好散热条件验证下的结果。客户端将 LED 应用于串、并联线路时，需自行评估电流、电压分配、散热等问题。
- 3.The technical information shown in the data sheets is limited to the typical characteristics and circuit examples of the referenced products. It does not constitute the warranting of industrial property nor the granting of any license. 以上技术数据仅为产品的典型值，只作为参考，不作为任何应用条件及应用方式的保证。



3.SMTReflow Soldering Instructions SMT 回流焊说明

3.1SMT Reflow Soldering Instructions SMT 回流焊说明

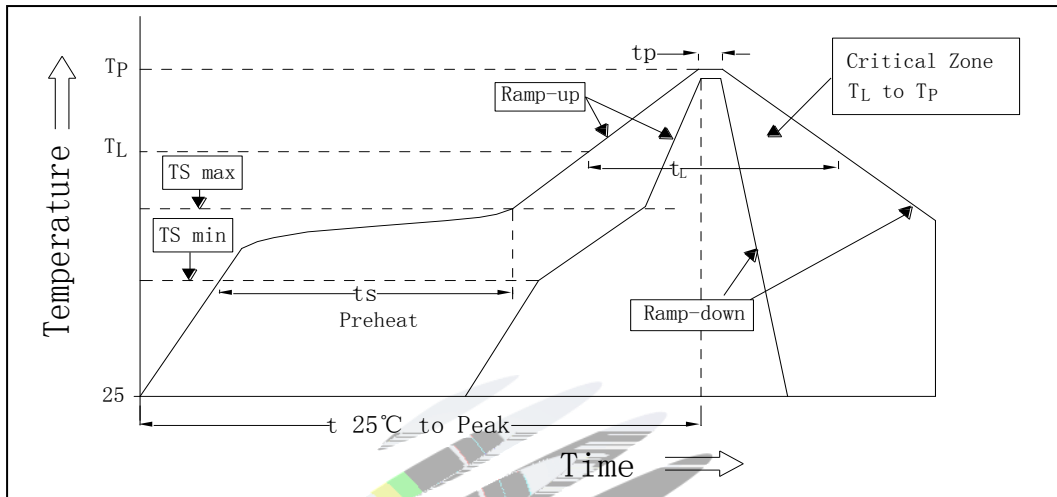
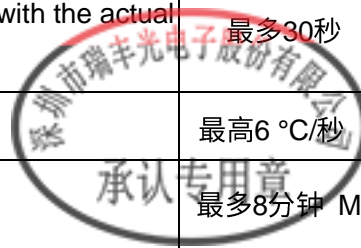

Fig.3-1SMT Reflow Soldering Instructions SMT 回流焊说明

Table 3-1Reflow parameters 回流焊参数

Average temperature rise speed平均升温速度 (Tsmax至Tp)	最高3 °C/秒 Max 3 °C/ s
Preheating: minimum temperature预热: 最低温度 (Tsmín)	150 °C
Preheating: Max temperature预热: 最高温度 (Tsmáx)	200 °C
Preheating: Time预热: 时间 (Tsmín至Tsmáx)	60 - 120秒 60s-120s
Time limited to maintain high temperature: the temperature限时维持高温: 温度 (Tl)	217 °C
Time limited to maintain high temperature: The Time 限时维持高温: 时间 (tl)	最多60秒 Max 60s
Peak /Classification of temperature:峰值 / 分类温度 (Tp)	260 °C
Time limit classification of peak temperature time限时峰值分类温度: 时间 (tp)	最多10秒 Max 10s
与实际峰值温度 (Tp) 相差 5 °C 以内的保持时间 Hold time within 5 °C with the actual peak temperature (TP)	最多30秒 Max 30s
降温速度 Cooling speed	最高6 °C/秒 Max 6 °C/ s
25 °C 升至峰值温度所需时间 Needed time from 25 °C to Tp	最多8分钟 Max 8 minutes



Notes 备注:

(1)Reflow soldering should not be done more than twice. If more than 24 hours between the two soldering,LED will be damaged. 回流焊次数不可以超过两次，两次回流焊的时间间隔如果超过24小时，LED可能由于吸湿而损坏。

(2)Whensoldering , do not put stress on the LEDs during heating.当焊接时，不要在材料受热时用力压胶体表面。

3.1.1 Soldering Iron 烙铁焊接

(1) When do soldering by hand, keep the temperature of iron below less 300°C less than 3 seconds 当手工焊接时,烙铁的温度必须小于300°C，时间不可超过3秒。

(2) Soldering by hand should be done only one time.手工焊接只可焊接一次。

3.1.2 Repairing 维修

Repairing should not be done after the LEDs have been82 0560.bs have been82 0560.bs have been82Q EMC /P A

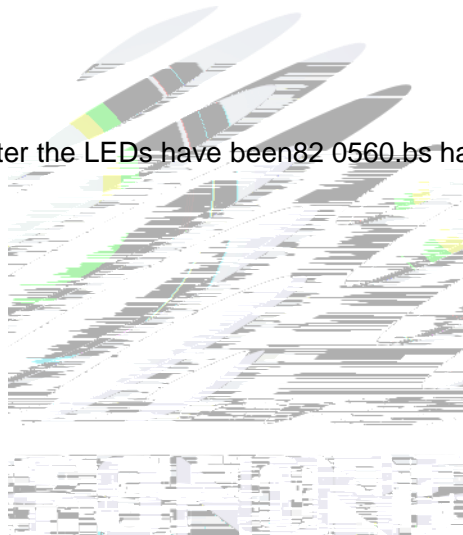

4. Handling Precautions 产品使用注意事项

4.1 Handling Precautions 产品使用注意事项

(1) LED operating environment and sulfur element composition cannot be over 100PPM in the LED mating usage material. This is provided for informational purposes only and is not a warranty or endorsement. LED 工作环境及与 LED 适配的材料中硫元素及化合物成份不可超过 100PPM. 这只是一个建议, 不作任何品质担保。

(2) In order to prevent ex-ternal material from getting into the inside of LED, which may cause the malfunction of LED, the single content of Bromine element is required to be less than 900PPM, the single content of Chlorine element is required to be less than 900PPM, the total content of Bromine element and Chlorine element in the external materials of the application products is required to be less than 1500PPM. This is provided for informational purposes only and is not a warranty or endorsement. 为了防止外界物质进入 LED 内部以造成 LED 的损伤, 所处环境及所用套件等等, 单一的溴元素含量要求小于 900PPM, 单一氯元素含量要求小于 900PPM, 溴元素与氯元素总含量必须小于 1500PPM. 这只是一个建议, 不作任何品质担保。

(3) VOCs (Volatile organic compounds) emitted from materials used in the construction of fixtures can penetrate silicone encapsulants of LEDs and discolor when exposed to heat and photonic energy. The result can be a significant loss of light output from the fixture. Knowledge of the properties of the materials selected to be used in the construction of fixtures can help prevent these issues. Refond advises against the use of any chemicals or materials that have been found or are suspected to have an adverse affect on device performance or reliability. To verify compatibility, Refond recommends that all chemicals and materials be tested in the specific application and environment for which they are intended to be used. Attaching LEDs, do not use

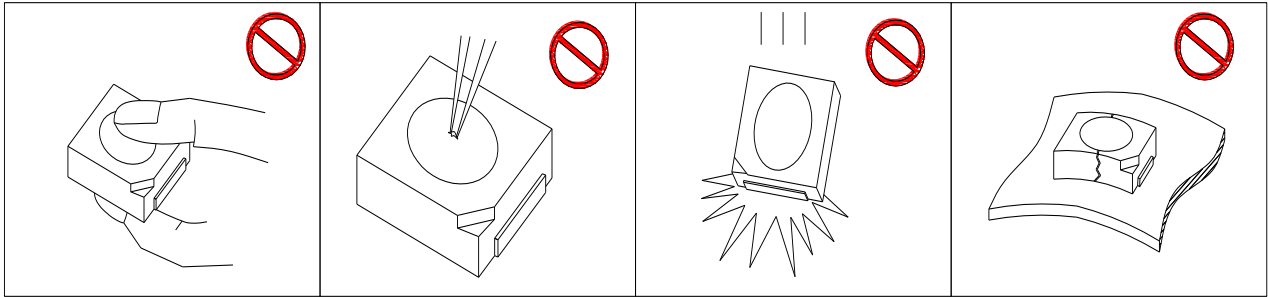

Fig 4-1 Handling Precautions 产品使用注意事项

(5) In designing a circuit, the current through each LED can not exceed the absolute maximum rating specified for each LED. In the meanwhile, resistors for protection should be applied, otherwise slight voltage shift will cause big current change, burn out may happen. The driving circuit must be designed to allow forward voltage only when it is ON or OFF. If the reverse voltage is applied to LED, migration can be generated resulting in LED damage. 设计电路时，通过 LED 的电流不能超过规定的最大值，同时，还需使用保护电阻，否则，微小的电压变化将会引起较大电流变化，可能导致产品损毁。电路设计必须保证只有在开启或者关闭的时候出现正向电压的变化，不要施加反压，否则会损坏 LED。

(6) Thermal Design is paramount importance because heat generation may result in the Characteristics decline, such as brightness decreased, Color change and so on. Please consider the heat generation of the LEDs when making the system design. LED 容易因为自身的发热和环境的温度改变而改变。温度升高会降低 LED 发光效率，影响发光颜色，所以在设计时应充分考虑散热问题。

(7) Compared to standard encapsulants, silicone is generally softer, and the surface is more likely to attract dust, requiring special care during processing. In cases where a minimal level of dirt and dust particles cannot be guaranteed, a suitable cleaning solution must be applied to the surface after the soldering of components. Refond suggests using isopropyl alcohol for cleaning. In case other solvents are used, it must be assured that these solvents do not dissolve the package or resin. Ultrasonic cleaning is not recommended. Ultrasonic cleaning may cause damage to the LED. 与其他封装胶相比，硅胶通常较软，表面易吸附脏物，应用时应特别注意。当对产品洁净度要求较高时，同封装以后需要采用恰当的清洗方式。我们推荐使用异丙醇作清洗剂，如需用到其他清洗剂，必须保证不会破坏封装体，超声清洗可能会对 LED 带来损害，不推荐这种清洗方式。



Table 4-1 Storage 儲存

Conditions 种类		Temperature	Humidity 湿度	Time 时间
Storage 儲存	Before Opening Aluminum Bag 拆包前	30°C	75%	Within 1 Year From Date
	After Opening Aluminum Bag 拆包后	30°C	60%	Recommended for use within 24 hours 建议24小时内使用
Baking 烘烤		60±5°C	-	≥24hours 大于24小时

(8) If the moisture absorbent material (silica gel) has faded away or the LEDs have exceeded the storage time, baking treatment should be performed after unpacking and based on the following condition (60±5)°C for above 24 hours. 如果干燥剂失效或者产品不符合以上存储条件，需拆包后进行烘烤。烘烤条件 60±5°C，大于 24 小时。

If the package is flatulence or damaged, please notify the sales staff to assist. 如果包装胀气或者破损，请通知销售人员协助处理。

(9) Similar to most Solid state devices; LEDs are sensitive to Electro-Static Discharge (ESD) and Electrical Over Stress (EOS). 像其他的半导体电子器件一样，LED 对静电过流击穿非常敏感，需要做好防护。

(10) Other points for attention, please refer to our relevant information. 其它注意事项请参照瑞丰相关资料。



Date日期	Revisor修订者	Version版本	Verifier审核	Remarks备注
2023/02/02	陈炜雄 Chen Weixiong	E0	朱益明 Zhu yiming	新发行

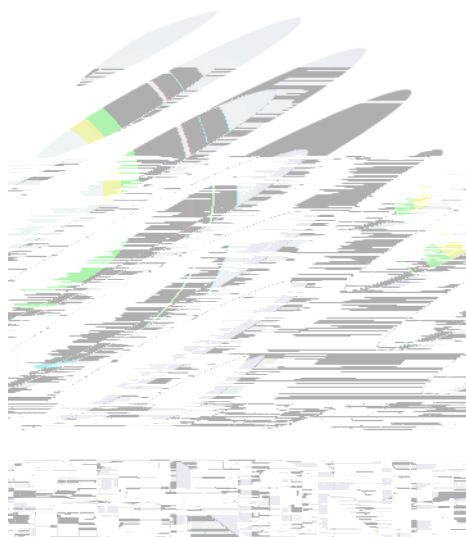



www.refond.com



Declare 申明

This specification is written both in English and in Chinese and the latter is formal.

产品规格书以中英文方式书写，如有冲突以中文版为准