

# SPECIFICATION

REFOND P/N

RF-A3H10-WYSP-E5

D<sup>~</sup> 6

Mass Production

## Contents

1. Description	3
1.1 General Description	3
1.2 Features	3
1.3 Application	3
1.4 Package Dimension	4
1.5 Product Parameters	5
1.6 Bin Range Of Forward Voltage and Luminous Flux (IF=1000mA)	<b>BIN</b>
(IF=1000mA)	6
1.7 Typical optical characteristics curves	8
2. Packaging	12
2.1 Packaging Specification	12
2.1.1 Carrier Tape Dimension	12
2.1.2 Reel Dimension	12
2.1.3 Label Form Specification	13
2.3 Cardboard Box	13
2.4 Reliability Test Items And Conditions	14
2.5 Criteria For Judging Damage	15
3. SMT Reflow Soldering Instructions SMT	16
3.1 SMT Reflow Soldering Instructions SMT	16
4. Handling Precautions	18

# 1. Description

## 1.1 GeneralDescription

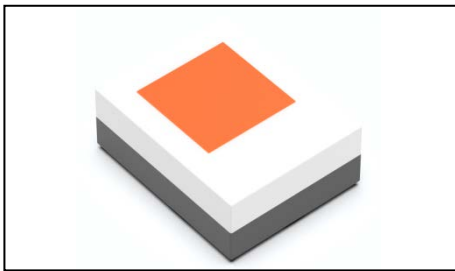

This product uses the ceramics package, it has a high reliability. it also be widely application for Automotive Exterior Lighting. Size(mm): 2.00X1.60X0.80mm.

2.00X1.60X0.80mm

## 1.2 Features

y Ceramic Package.

yHigh Power Output and High Luminance.

yPb -free reflow soldering application.

yMoisture sensitive level:Level2. Level 2

yRoHS compliant. RoHS

y Qualifications: The product qualification test plan is based on the guidelines of AEC-Q102 Stress Test Qualification for Automotive Grade Discrete Semiconductors

375℃#"

## 1.3 Application

yAutomotive Exterior Lighting, Cornering Light.

## 1.4 Package Dimension

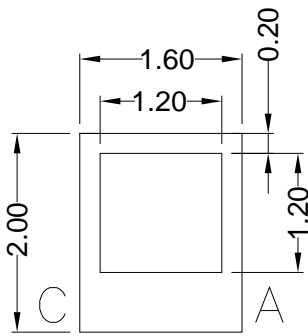

Fig.1-1 Top View

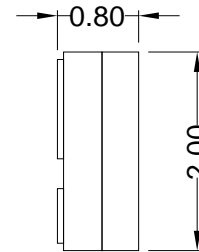

Fig.1-2 Side View

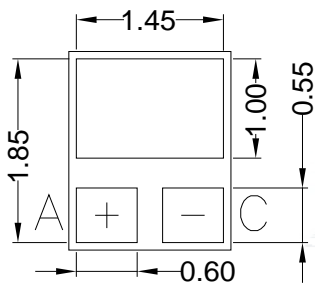

Fig.1-3 Bottom View

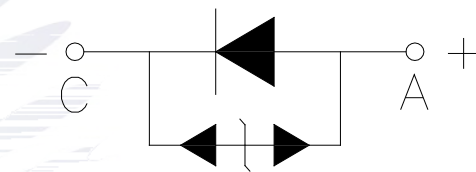

Fig.1-4 Polarity

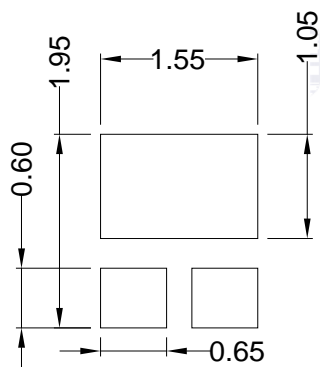

Fig.1-5 Soldering Patterns

### Notes

# All dimensions units are millimeters.

\$ All dimensions tolerances are  $\pm 0.2\text{mm}$  unless otherwise noted.

f " Z

## 1.5 Product Parameters

Table 1-1 Electrical / Optical Characteristics at Ts=25°C

Item	Symbol	Test Condition	Value			Unit
			Min.	Typ	Max.	
Forward Voltage	$V_F$	$I_F=1000\text{mA}$	2.8	---	3.4	V
Reverse Current	$I_R$	$V_R=5\text{V}$	---	---	10	$\mu\text{A}$
luminous flux ( )	-	$I_F=1000\text{mA}$	200	---	280	lm
Viewing Angle		$I_F=1000\text{mA}$	---	120	---	deg
Color Rendering Index / fi	$R_a$	$I_F=1000\text{mA}$	---	---	---	---
Thermal Resistance.	$R_{THJ-S}$	$I_F=1000\text{mA}$	---	4.1	5.5	/W

Table 1-2 Absolute Maximum Ratings at Ts=25°C

Parameter	Symbol	Rating	Units
Power Dissipation	$P_D$	5100	mW
Forward Current	$I_F$	1500	mA
Peak Forward Current	$I_{FP}$	2000	mA
Reverse Voltage	$V_R$	5	V
Electrostatic Discharge (HBM)	$E_{SD}$	8000	V
Operating Temperature	$T_{OPR}$	-40 ~ +125	°C
Storage Temperature	$T_{STG}$	-40 ~ +125	°C
Junction Temperature	$T_J$	150	°C

Notes

1. 1/10 Duty cycle, 10ms pulse width. 10ms 1/10.
2. The above forward voltage measurement allowance tolerance is  $\pm 0.1V$ .  $\pm 0.1V$
3. The above color coordinates measurement allowance tolerance is 0.003. 0.003
4. The above luminous flux measurement allowance tolerance  $\pm 10\%$ .  $\pm 10\%$ .
5. Care is to be taken that power dissipation does not exceed the absolute maximum rating of the product.
6. All measurements were made under the standardized environment of Refond.
7. When the LEDs are in operation the maximum current should be decided after measuring the package temperature. Junction temperature should not exceed the maximum rated  $>76$ .
8. ESD yield is over 90% at 8000V ESD (HBM). ESD protection during products handling is needed.  $>76$ .

## 1.6 Bin Range Of Forward Voltage and Luminous Flux (IF=1000mA)

### BIN (IF=1000mA)

Table 1-3

V <sub>F</sub> (V)	G0	H0	I0	
	2.8-3.0	3.0-3.2	3.2-3.4	
- (lm)	FB	FC	BA	BB
	200-220	220-240	240-260	260-280

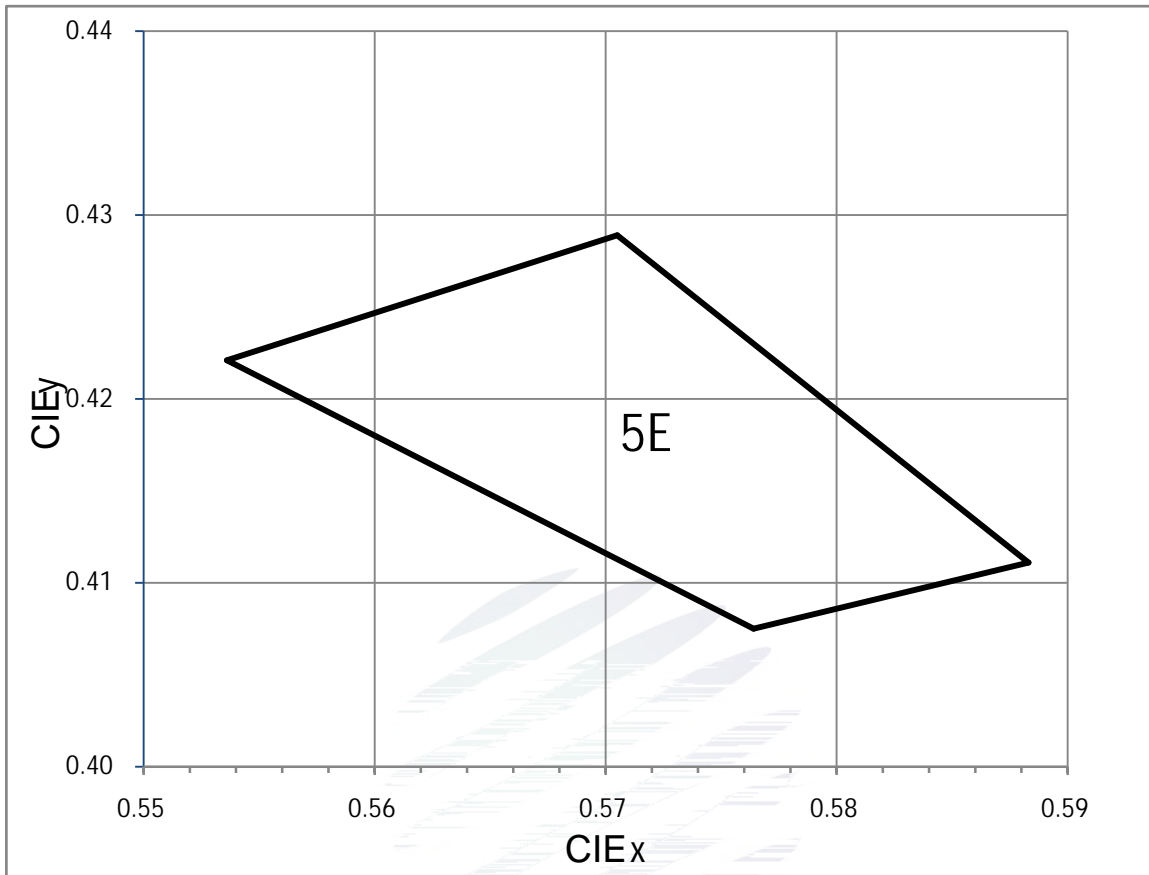

### Bin dataH

BIN CODE	X1	Y1	X2	Y2	X3	Y3	X4	Y4
5E	0.5536	0.4221	0.5764	0.4075	0.5883	0.4111	0.5705	0.4289

## 1.7 Typical optical characteristics curves

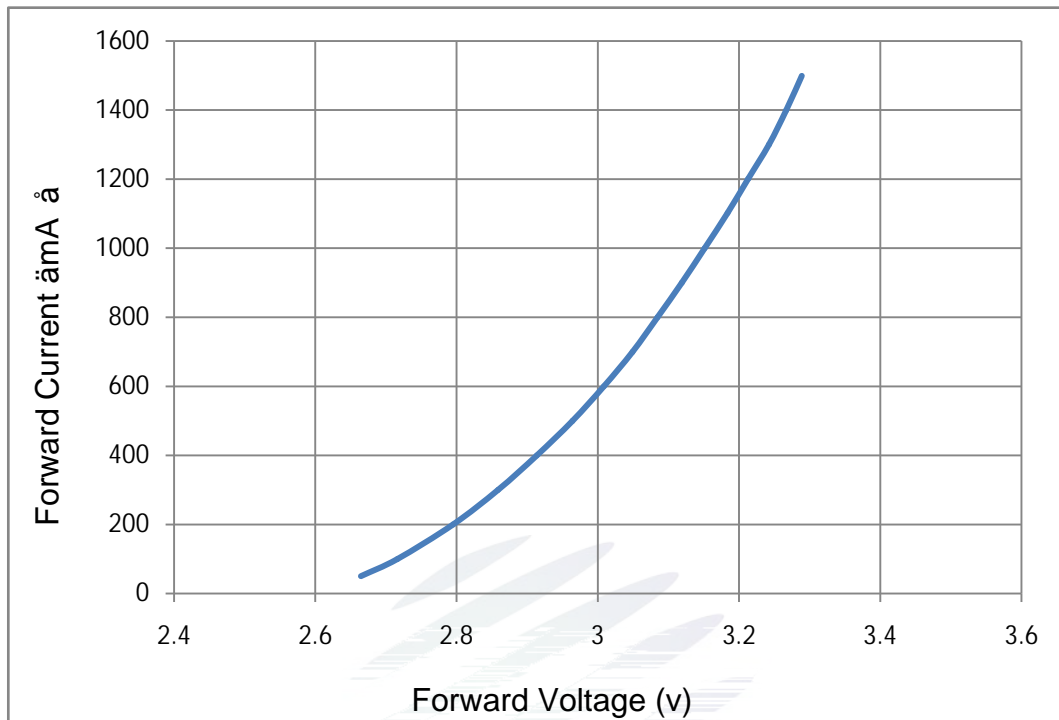

Fig 1-6 Forward Voltage Vs. Forward Current

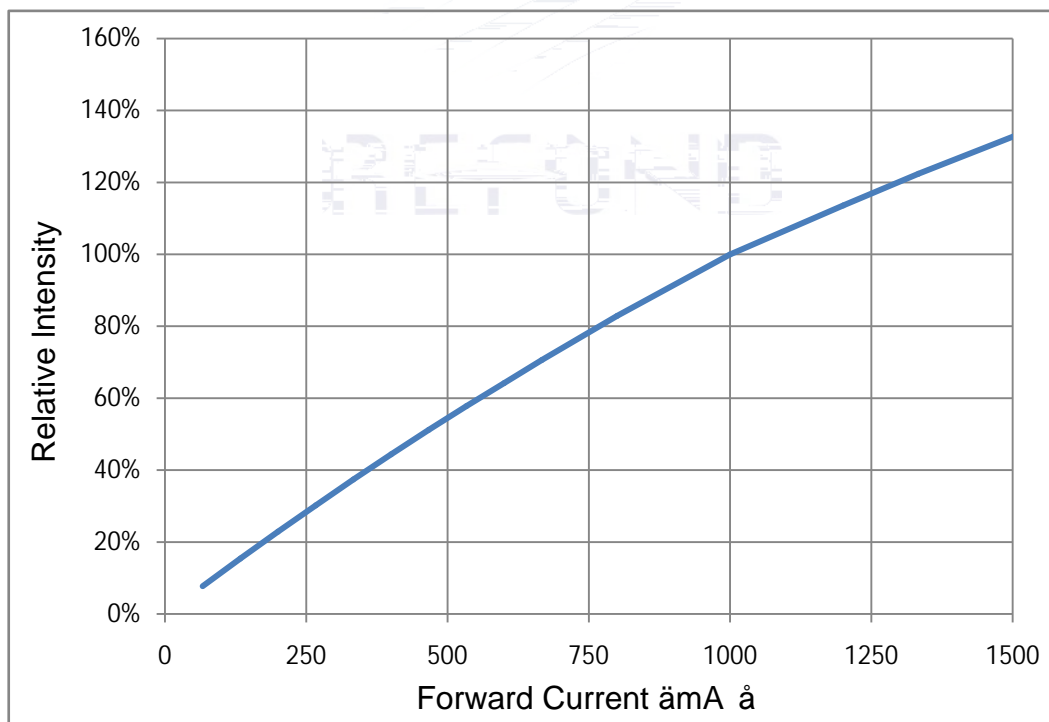

Fig 1-7 Forward Current Vs. Relative Intensity





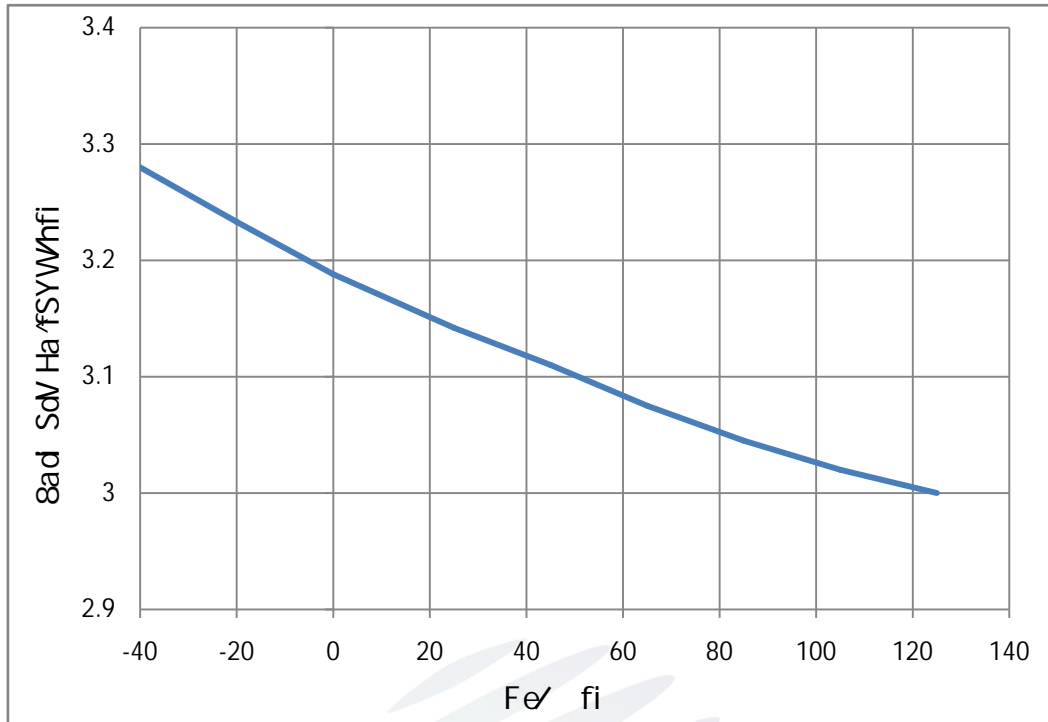

Fig. 1-10 Forward Voltage Vs Solder Temperature

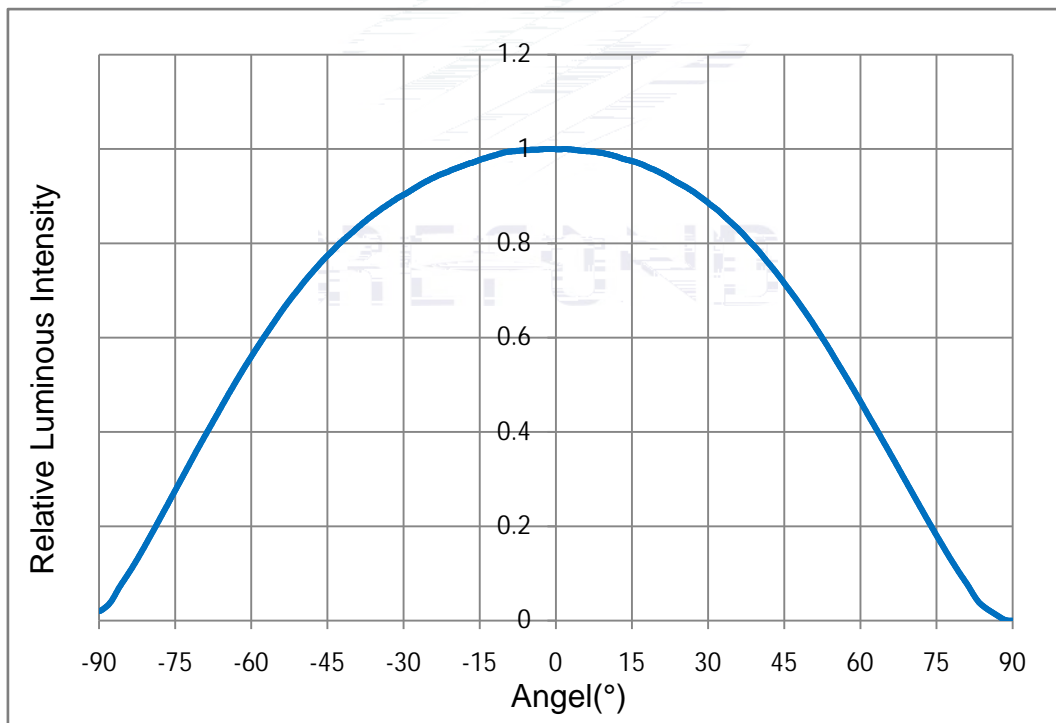

Fig 1-11 Radiation diagram

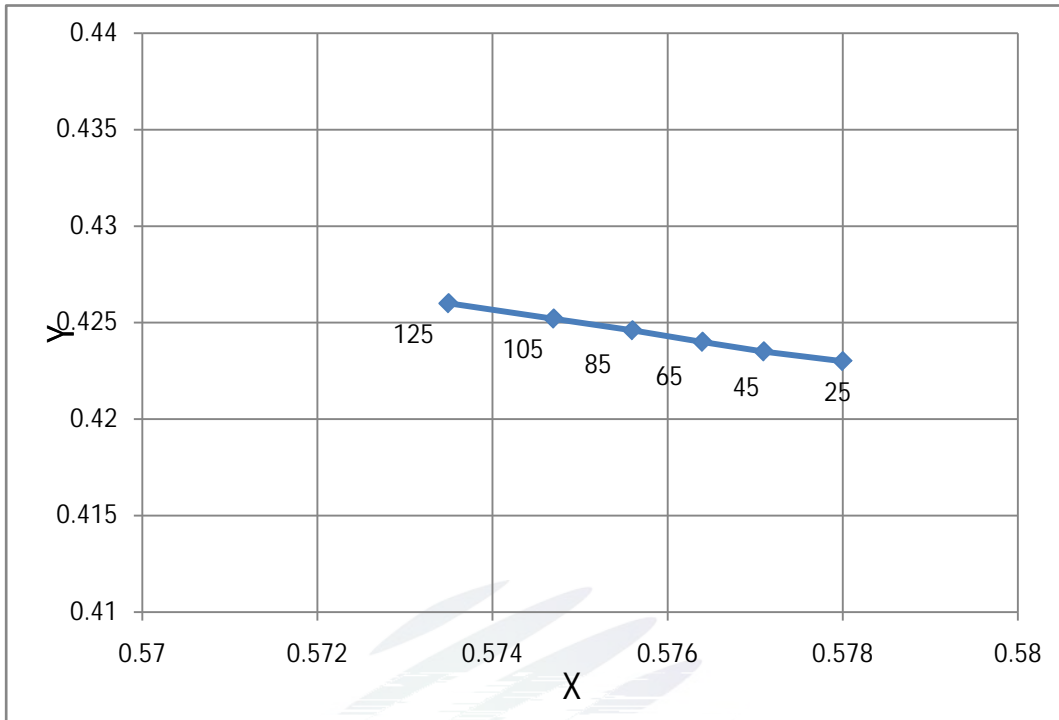

Fig. 1-12 Chromaticity Coordinate Vs Solder Temperature

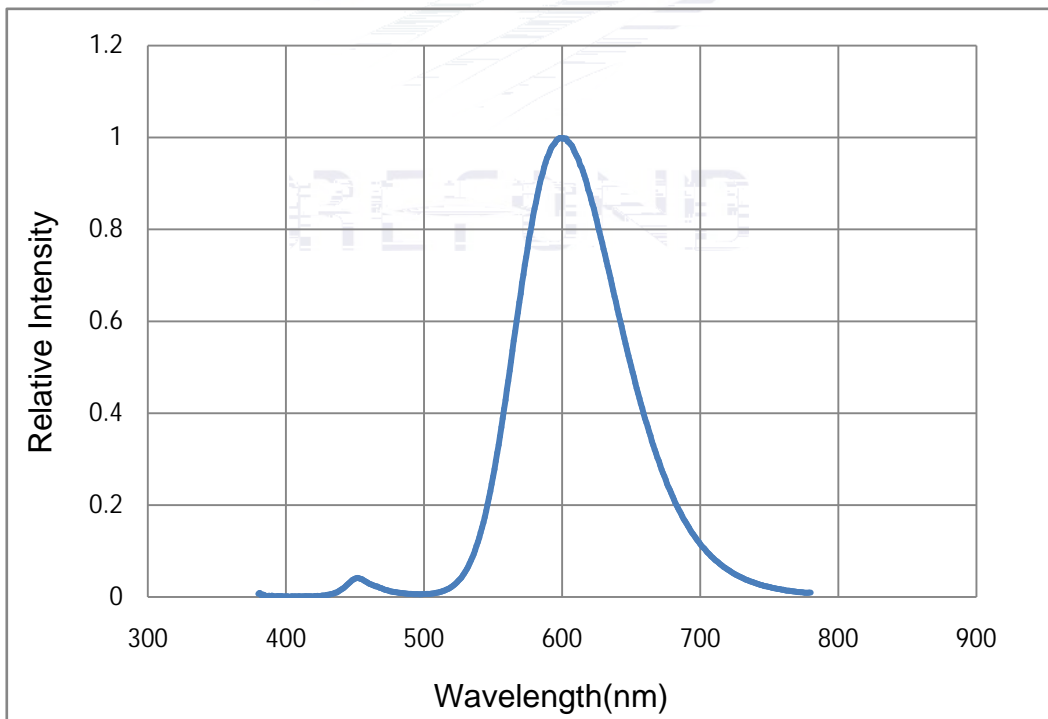

Fig 1-13 Spectrum Distribution

## 2. Packaging

### 2.1 Packaging Specification

Package:4000pcs/reel.      &" " " bUe

#### 2.1.1 Carrier Tape Dimension



Fig.2-1 Carrier Tape Dimension

#### 2.1.2 Reel Dimension

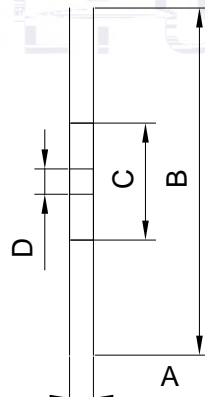
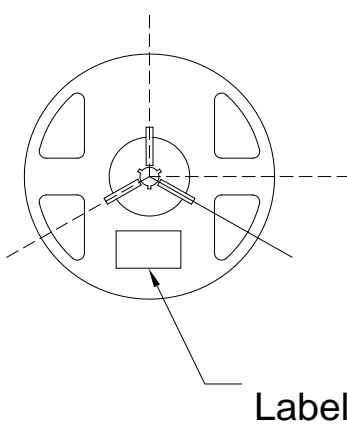

Table 2-1 Dimension

A	11.4±0.3mm
B	180±2mm
C	60.0±1mm
D	13.0±0.2mm

Fig.2-2Reel Dimension

#### Notes

The tolerances unless mentioned ±0.1mm. Unit : mm <•pÉ6Ö<•! -- â±0. 1;“L +â+ "ý õpÉ;“L

### 2.1.3 Label Form Specification

Table 2-2 Label Form Specification

PART NO	Part Number
SPEC NO	Spec Number
LOT NO	Lot Number
BIN CODE	Bin Code
N	Luminous flux $v \hat{A}$
X/Y	Chromaticity Bin, $\emptyset$
V <sub>F</sub>	Forward Voltage
QTY	Packing Quantity
DATE	Made Date

Fig 2-3 Label Form Specification

### 2.2 Moisture Resistant Packing

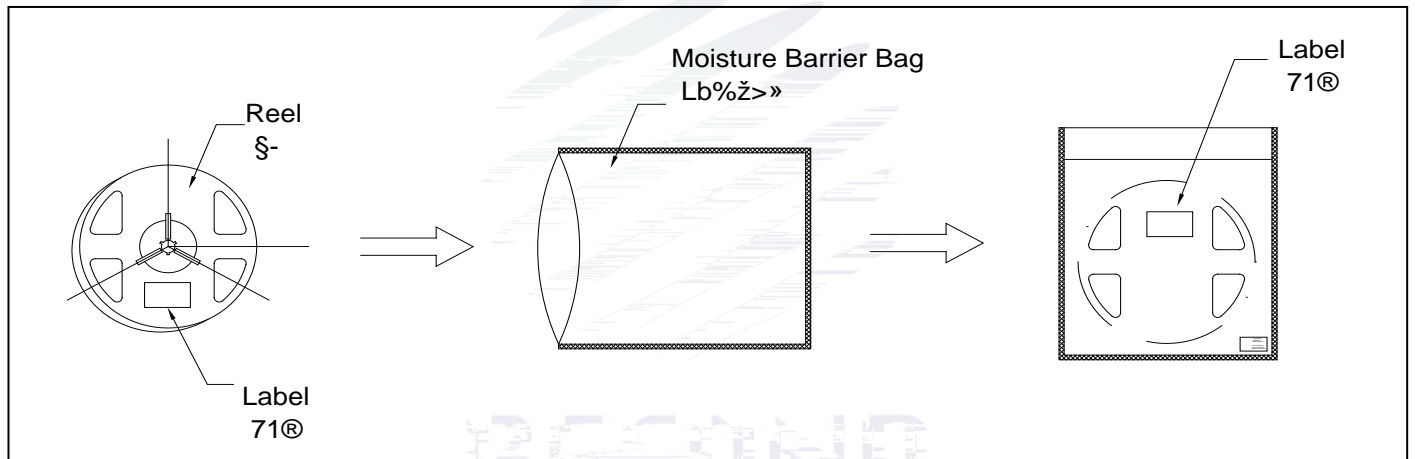

Fig.2-4 Moisture Resistant Packing

### 2.3 Cardboard Box

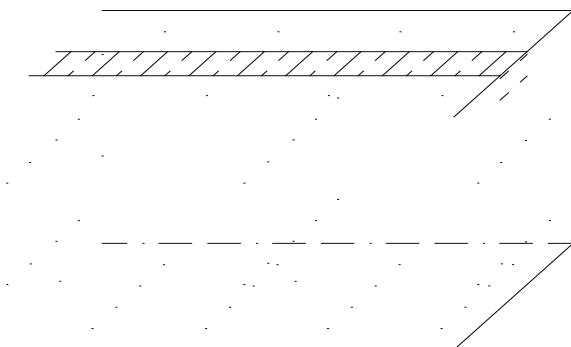

Fig.2-5 Cardboard Box

## 2.4 Reliability Test Items And Conditions

Table 2-3 Reliability Test Items And Conditions

Test Items	Ref.Standard	Test Condition	Time	Quantity	Ac/Re /
Reflow	JESD22-B106	Temp:260 max T=10 sec	2times	20pcs.	0/1
MSL2 2	JESD22-A113	85 / 60%RH	168 hrs.	20pcs.	0/1
Thermal Shock	JEITAED-4701 300307	-40 15min 9 ;10s 125 15min	1000 cycle	20pcs.	0/1
Life Test	JESD22-A108	Ta=125 IF=1000mA	1000hrs.	20pcs.	0/1
High Temperature High Humidity Life Test	JESD22-A101	85 / 85%RH IF=1000mA	1000hrs.	20pcs.	0/1

## 2.5 Criteria For Judging Damage

Table Criteria For Judging Damage

Test Items	Symbol	



### 3. SMT Reflow Soldering Instructions SMT

#### 3.1 SMT Reflow Soldering Instructions SMT

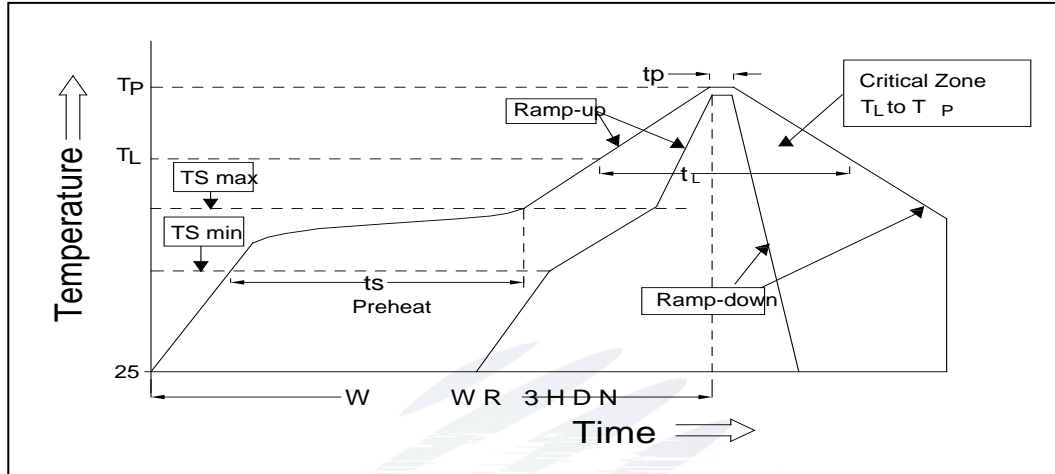

Fig.3-1 SMT Reflow Soldering Instructions SMT

Table 3-1 SMT Reflow Soldering Instructions SMT

Average temperature rise speed	Tsmax	Tp	3 °C/	Max 3 °C/ s
Preheating: minimum temperature	(Tmin)		150 °C	
Preheating: Max temperature	(Tmax)		200 °C	
Preheating: Time	Tmin	Tmax	60 - 120	60s-120s
Time limited to maintain high temperature: the temperature (TL)			217 °C	
Time limited to maintain high temperature: The Time (tL)			60	Max 60s
Peak /Classification of temperature	/ (Tp)		260 °C	
Time limit classification of peak temperature time			10	Max 10s
Hold time within 5 °C with the actual peak temperature (Tp)	5 °C		30	Max 30s
Cooling speed			6 °C/	Max 6 °C/ s
Needed time from 25 °C to Tp	25 °C		8	Max 8 minutes



## Notes

(1) Reflow soldering should not be done more than two times. In the case of more than 24 hours passed soldering after first, LEDs will be damaged. \$&

>76

(2) When soldering , do not put stress on the LEDs during heating.

### 3.1.1 Repairing

Repair should not be done after the LEDs have been soldered. When repairing is unavoidable,a double-head soldering iron should be used (as below figure). It should be confirmed in advance whether the characteristics of LEDs will or will not be damaged by repairing.

LED

>76

### 3.1.2 Cautions

(1) The encapsulated material of the LEDs is silicone. Therefore the LEDs have a soft surface on the top of package. The pressure to the top surface will be influence to the reliability of the LEDs. Precautions should be taken to avoid the strong pressure on the encapsulated part. So when use the picking up nozzle, the pressure on the silicone resin should be proper. LED

>76

(2) Components should not be mounted on warped (non coplanar) portion of PCB. After soldering, do not warp the circuit board.LED B54

(3) Do not apply mechanical force or excess vibration during the cooling process to normal temperature after soldering. Do not rapidly cool device after soldering.

## 4. Handling Precautions

(1) LED operating environment and sulfur element composition cannot be over 100PPM in the LED mating usage material. This is provided for informational purposes only and is not a warranty or endorsement. LED

&gt;76

# " BB? ž

(2) In order to prevent external material from getting into the inside of LED, which may cause the malfunction of LED, the single content of Bromine element is required to be less than 900PPM, the single content of Chlorine element is required to be less than 900PPM, the total content of Bromine element and Chlorine element in the external materials of the application products is required to be less than 1500PPM. This is provided for informational purposes only and is not a warranty or endorsement.

&gt;76

&gt;76

+ " BB?

+ " BB?

# " " BB? ž

(3) VOCs (Volatile organic compounds) emitted from materials used in the construction of fixtures can penetrate silicone encapsulants of LEDs and discolor when exposed to heat and photonic energy. The result can be a significant loss of light output from the fixture. Knowledge of the properties of the materials selected to be used in the construction of fixtures can help prevent these issues. Refond advises against the use of any chemicals or materials that have been found or are suspected to have an adverse affect on device performance or reliability. To verify compatibility, Refond recommends that all chemicals and materials be tested in the specific application and environment for which they are intended to be used. Attaching LEDs, do not use adhesives that outgas organic vapor.

&gt;76

&gt;76

&gt;76

&gt;76

(4) Handle the component along the side surface by using forceps or appropriate tools; do not directly touch or Handle the silicone lens surface, it may damage the internal circuitry.

Fig 4-1

(5) In designing a circuit, the current through each LED must not exceed the absolute maximum rating specified for each LED. In the meanwhile, resistors for protection should be applied, otherwise slight voltage shift will cause big current change, burn out may happen. The driving circuit must be designed to allow forward voltage only when it is ON or OFF. If the reverse voltage is applied to LED, migration can be generated resulting in LED damage.

&gt;76

&gt;76

(6) Thermal Design is paramount importance because heat generation may result in the Characteristics decline, such as brightness decreased, Color change and so on. Please consider the heat generation of the LEDs when making the system design. LED

&gt;76

(7) Compared to standard encapsulants, silicone is generally softer, and the surface is more likely to attract dust requiring special care during processing. In cases where a minimal level of dirt and dust particles cannot

Table 4-1 Storage

Conditions		Temperature	Humidity	Time
Storage	Before Opening Aluminum Bag	30	75%	Within 1 Year From Date
	After Opening Aluminum Bag	30	60%	Recommended for use within 24 hours
Baking		60±5	-	24hours
				24

(8) If the moisture absorbent material· silica gelp, has faded away or the LEDs have exceeded the storage time» baking treatment should be performed after unpacking and based on the following conditionp· 60±5p, W for above 24 hours. ("

f ' \$&

If the package is flatulence or damaged, please notify the sales staff to assist.

(9) Similar to most Solid state devices; LEDs are sensitive to Electro-Static Discharge (ESD) and Electrical Over Stress (EOS). >76

(10) Other points for attention, please refer to our relevant information.

## Version History/

Date	Revisor	Version	Verifier	Remarks
2022/05/10	~CT Xian Zhou	E0	a,ú > Zhu Yiming	à >  New issue
2023/09/28	Xian Zhou	E1	Zhu Yiming	Version update



Declare

This specification is written both in English and in Chinese and the latter is formal.