

G D

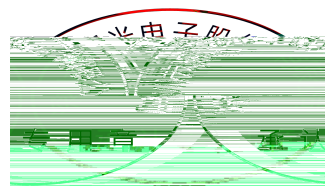

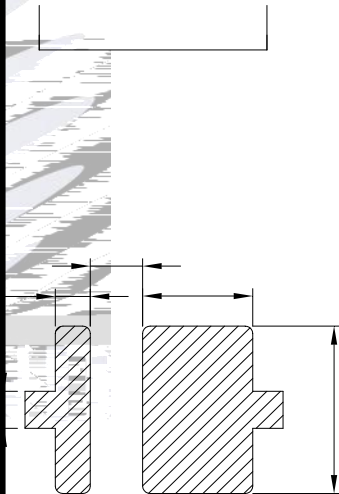

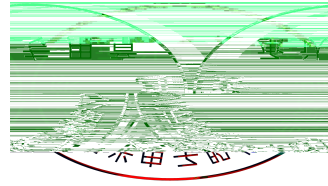

QAYEUA



豐光電

SHANGHAI

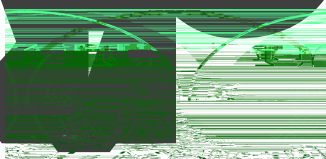

尔甲士加



μ XINRICH

30M

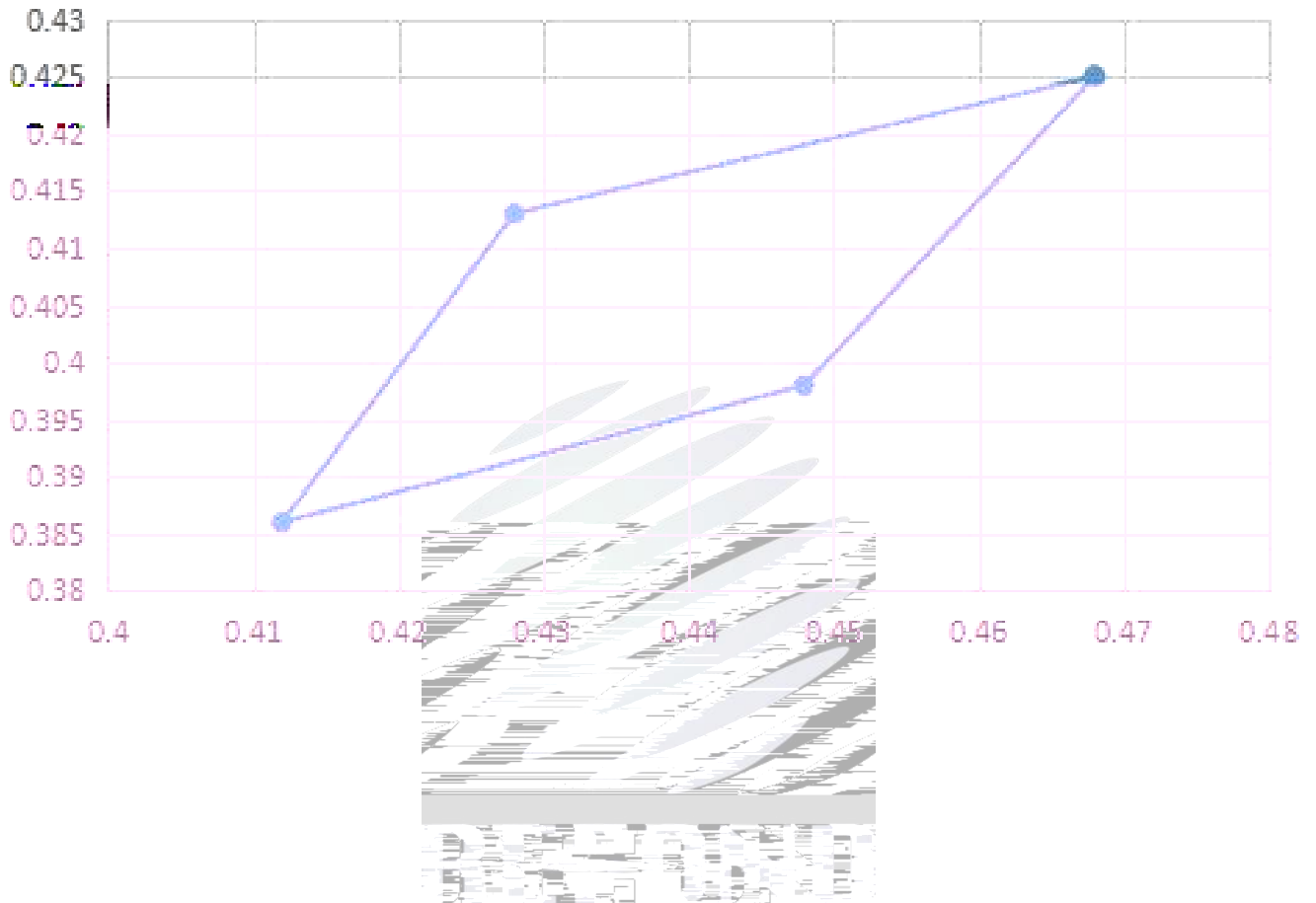

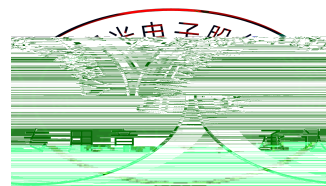

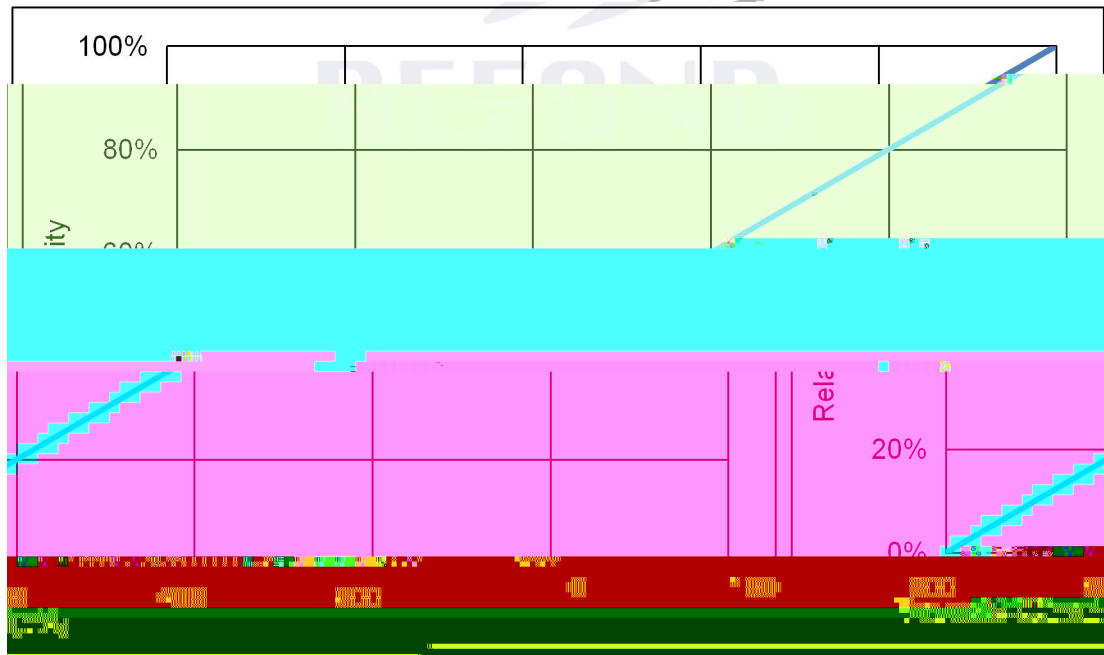
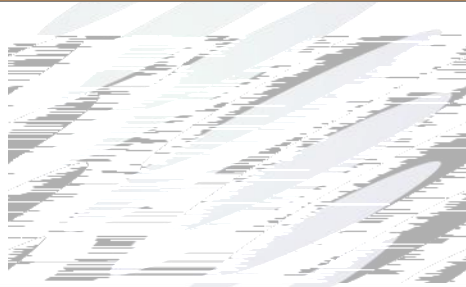
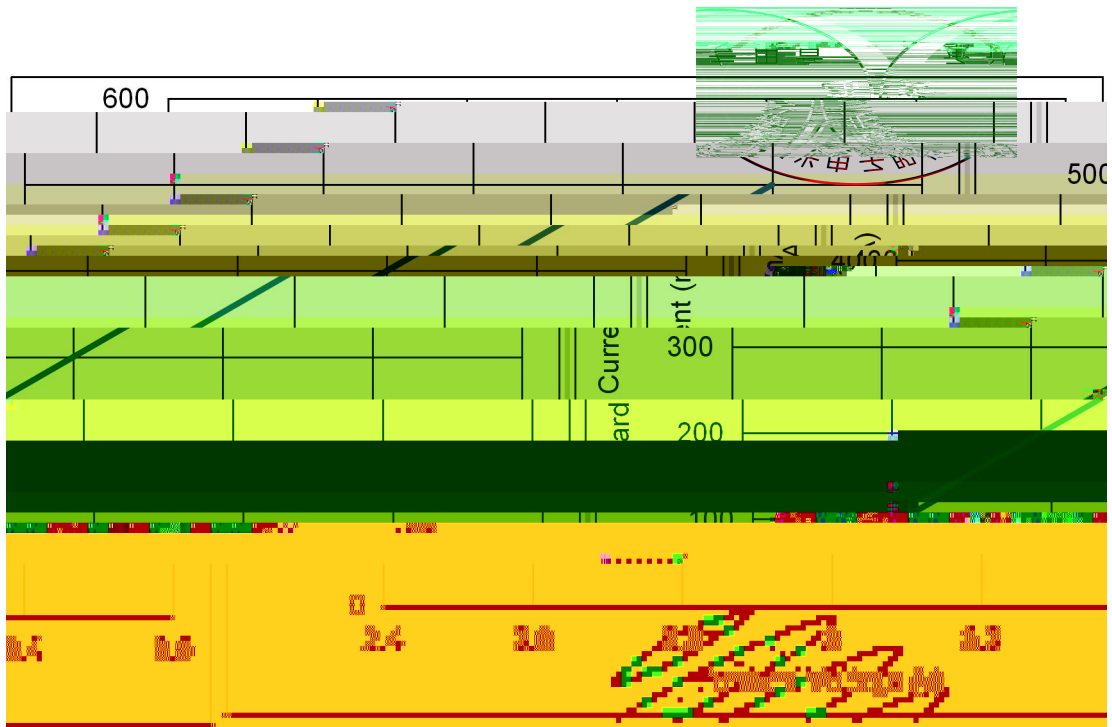

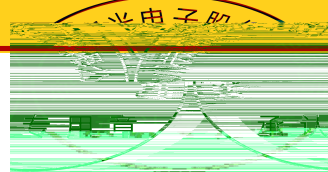
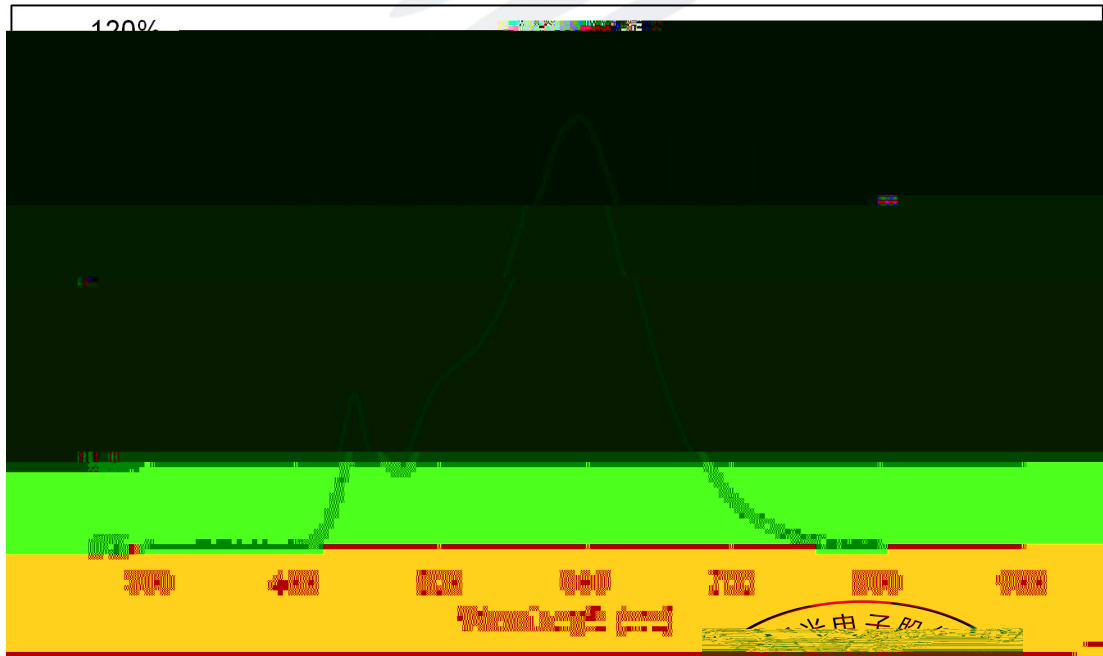
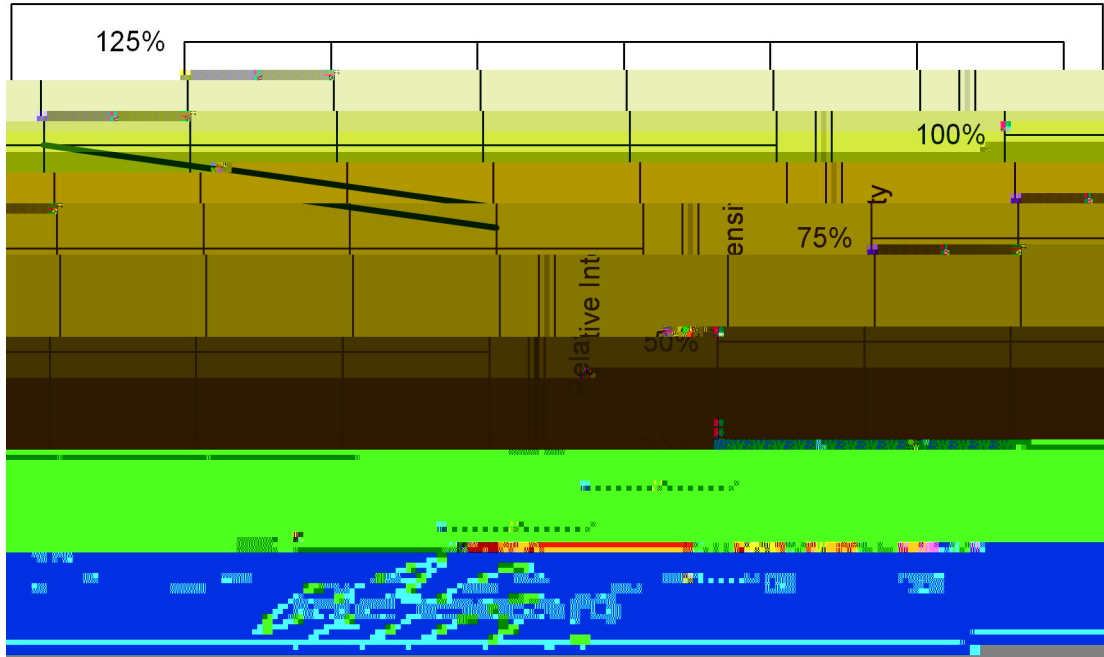

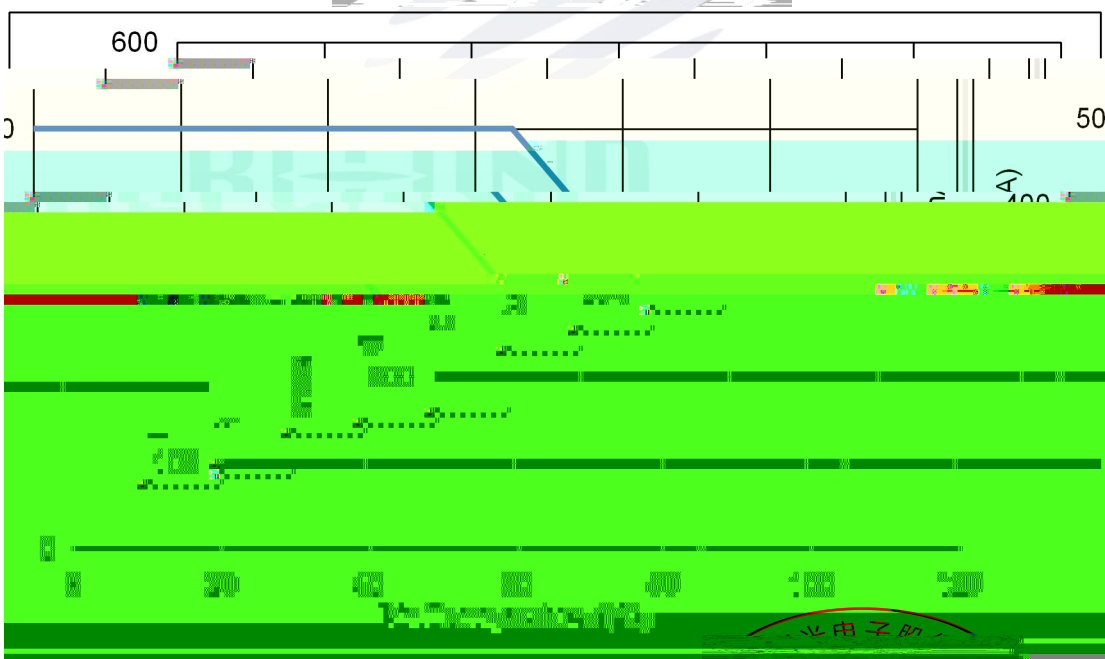
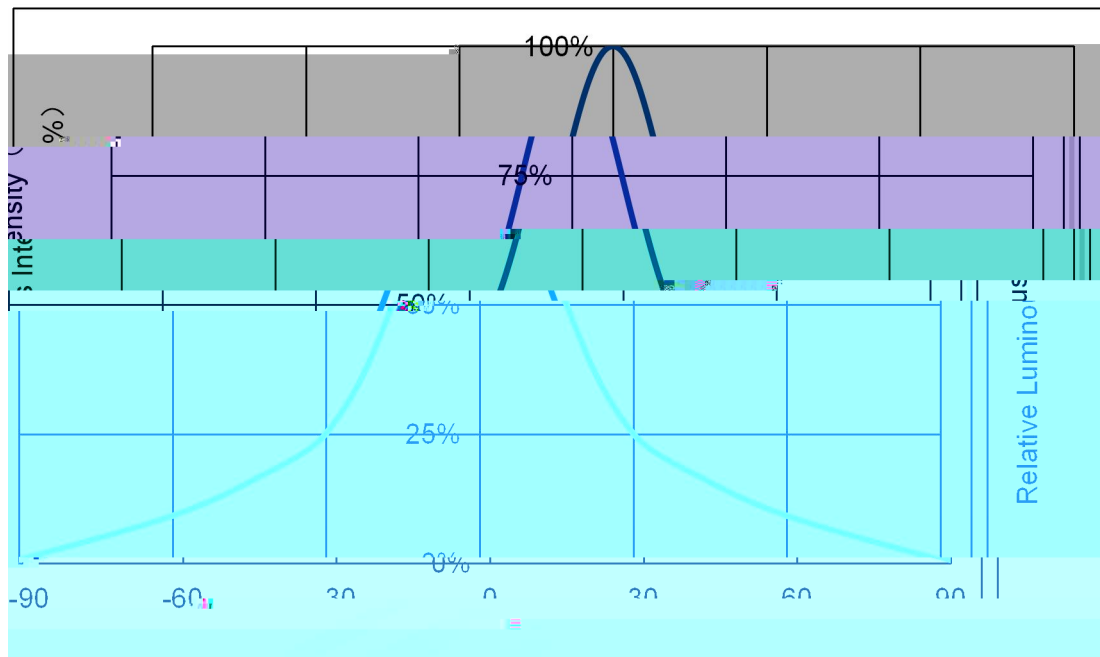

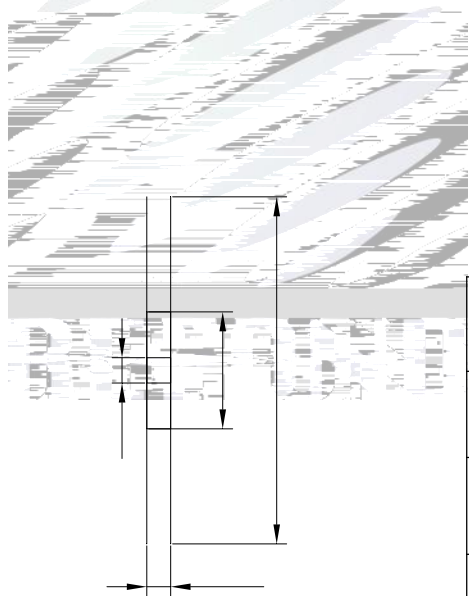
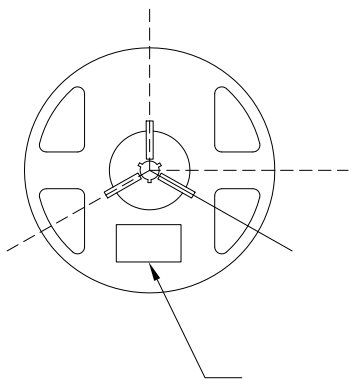
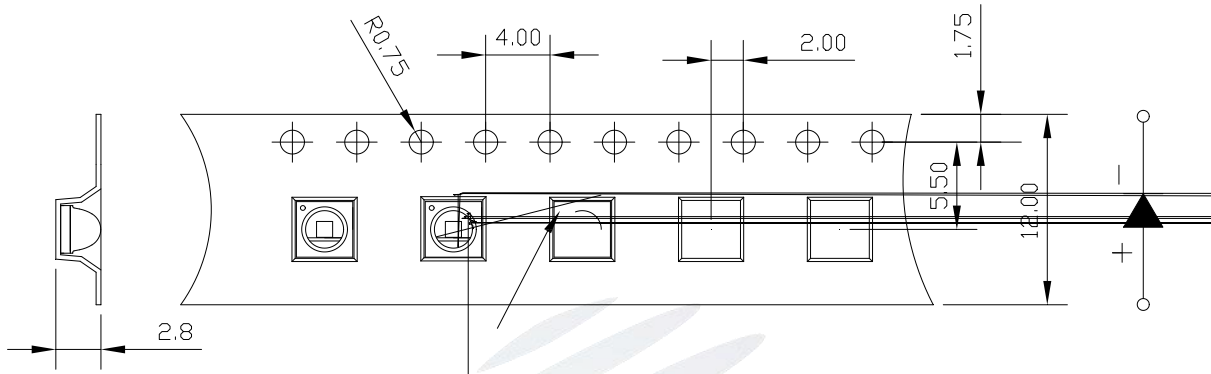

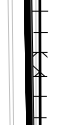
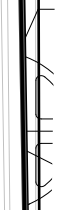

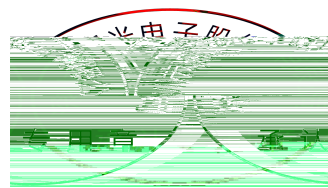

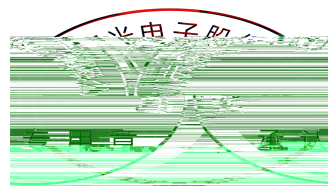

十年

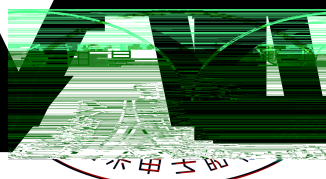

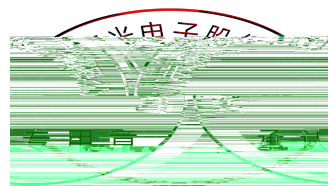

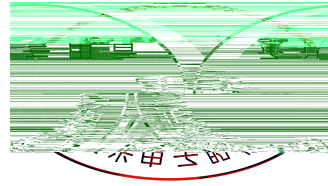



±

